

# The Johnson County Historic Poor Farm

MASTER PLAN - PHASE TWO 2017

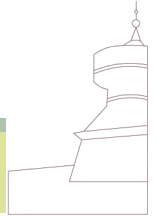

# Table of Contents



<b>Acknowledgements</b>	
<b>Project Background</b>	<b>1</b>
<b>Historic District &amp; Land Use Principles</b>	<b>2</b>
<b>Stakeholder Engagement &amp; Public Input</b>	<b>3</b>
<b>Current Uses</b>	<b>5</b>
<b>Woodland Inventory</b>	<b>6</b>
<b>Signage Packet</b>	<b>7</b>
<b>Housing Development Options</b>	<b>8</b>
<b>New Century Farm</b>	<b>9</b>
<b>Historic Building Complex</b>	<b>13</b>
<b>Priorities</b>	<b>17</b>
Short-Term (1-5 Years)	18
Long-Term (6+ Years)	23
<b>Cropland Phasing</b>	<b>25</b>
<b>Marketing &amp; Branding</b>	<b>27</b>
<b>Phase Three Recommendations</b>	<b>28</b>
<b>Appendices</b>	
<b>Appendix A: Woodland Inventory, Earthview Environmental, Inc.</b>	<b>29</b>
<b>Appendix B: Signage Packet, Confluence Landscape Architecture</b>	<b>45</b>
<b>Appendix C: Affordable Housing Options. The Housing Fellowship</b>	<b>61</b>



HBK Engineering  
509 South Gilbert Street  
Iowa City, Iowa 52240  
319-338-7557

Iowa Valley RC&D  
920 48th Avenue  
Amana, Iowa 52203  
319-622-3264

# Acknowledgements

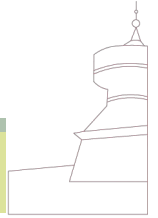

Our team is pleased to submit Phase Two of the Johnson County Historic Poor Farm Master Plan to the Johnson County Board of Supervisors.

Thank you to the Johnson County Board of Supervisors: Janelle Rettig, Kurt Friese, Mike Carberry, Rod Sullivan, and Lisa Green-Douglass. Thank you to the Johnson County Board of Supervisors Staff, the Planning Development and Sustainability Department, and the Johnson County Physical Plant Department. Thank you to: Leah D. Rogers, Director of Tallgrass Historians, LLC; Alexandra Drehman, Executive Director, Johnson County Historical Society; John Yeomans, Farm Manager, Farmers National Company; Kate Giannini, Soil and Water Conservation Coordinator for Johnson County and in partnership with the Johnson County Soil & Water Conservation District; Jennifer Price, Chair, Johnson County Historic Preservation Commission; Fred Meyer, Co-Director, Backyard Abundance; Maryanne Dennis, Executive Director, and Barbara Bailey, Finance Manager, The Housing Fellowship; Ayman, Sharif, President, Iowa Valley Global Food Project; John Boller, Director, GROW: Johnson County.

We would also like to thank the following for their contributions to this report:

- Johnson County Historic Preservation Commission
- Johnson County Historical Society
- Johnson County Conservation Board
- State Historical Society of Iowa
- Office of the State Archaeologist
- Iowa Valley Global Food Project
- City of Iowa City Staff
- Iowa City Parks and Recreation
- Johnson County Secondary Roads
- Iowa Department of Natural Resources
- Backyard Abundance
- Field to Family
- GROW: Johnson County
- Confluence Design Team
- Earthview Environmental

# Project Background

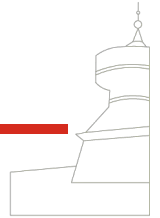

Phase Two is a continuation of work that began in Phase One, which was completed in July of 2017. During Phase One, the HBK Team completed a site analysis at the Poor Farm, reviewed current land uses and previous planning efforts, followed guidelines provided by the Johnson County Board of Supervisors, and engaged with a wide range of stakeholders. Our analysis culminated in a series of concepts, one of which was finally voted upon: The New Century Farm. This concept prioritizes preservation of the historical farm structures, land access and education for beginning farmers, conservation, recreation and education. Affordable housing options were included as an element to be explored following the mandate that the County maintains ownership of the land.

After the New Century Farm concept was chosen, the planning team was tasked with diving into the details of the site concept to develop short- and long-term project priorities. The following are included in this Phase Two Master Plan:

- A Description of Stakeholder Engagement
- Signage Packet (completed by Confluence Landscape Architecture & Urban Design)
- Woodland Survey (completed by Earthview Environmental, Inc.)
- Housing Development Options (in consultation with The Housing Fellowship)
- Analysis of Short-Term (1-5 years) Priorities
- Analysis of Long-Term (6-11 years) Priorities
- Phase Three Recommendations—Implementation

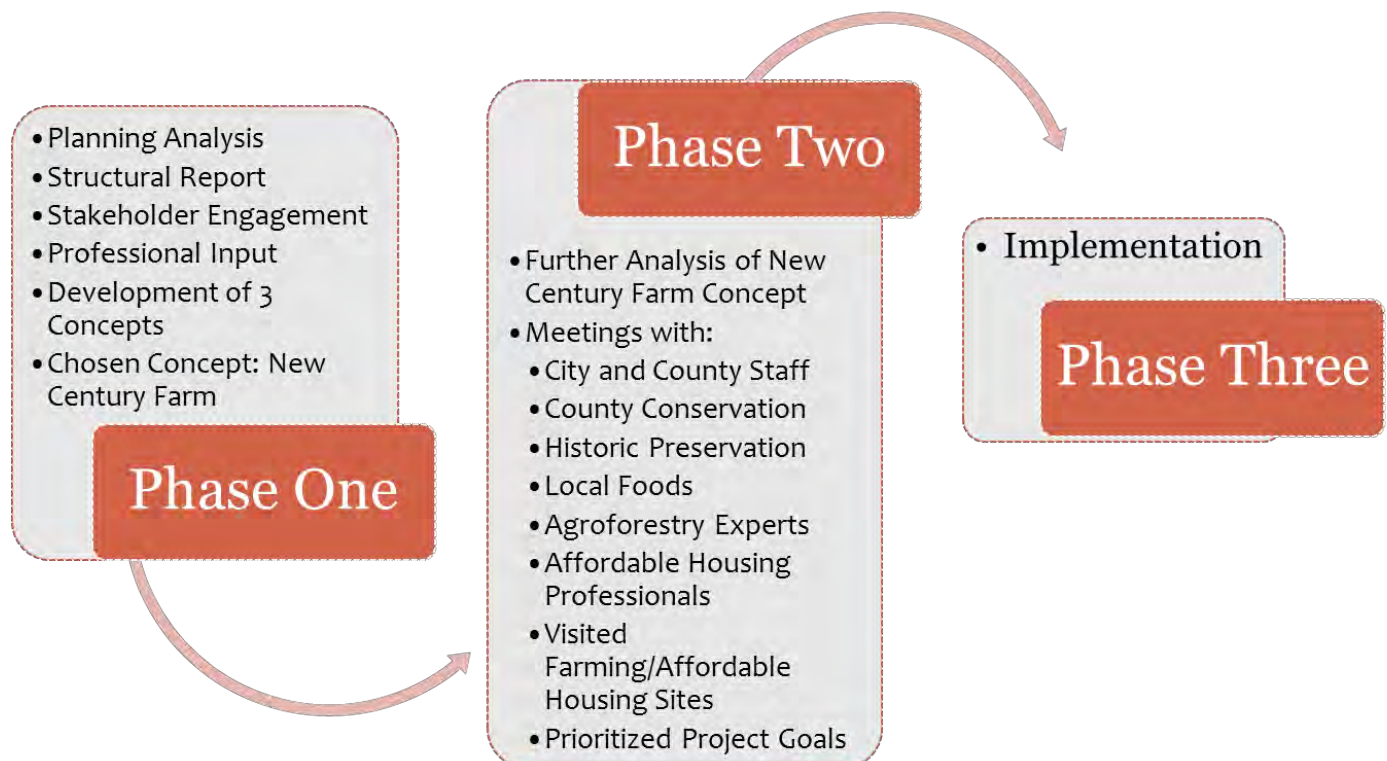

# Historic District & Land Use Principles

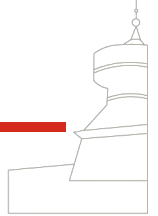

## Historic District

Based on the *2014 Poor Farm and Asylum Historic District Nomination* executed by Leah D. Rogers of Tallgrass Historians LLC (now Tallgrass Archaeology, LLC), which resulted in a National Register-listed Historic District in September of 2014, the Historic District encompasses 110 acres of the Poor Farm agricultural production and natural areas. This area includes the West Barn, the Dairy barn, the remaining wing of the Asylum, and the Cemetery.

Maintaining the National Register designation of the Johnson County Poor Farm and Asylum Historic District is a high priority and requires that the integrity of the property be preserved. Significant changes (alterations, demolitions, new construction, etc.) in the district may

result in the district being delisted. However, the [Secretary of the Interior's Standards for the Treatment of Historic Properties](#) provides guidance for the well-considered and sensitive rehabilitation of the historic property that respects its history while allowing for a compatible use in the future.

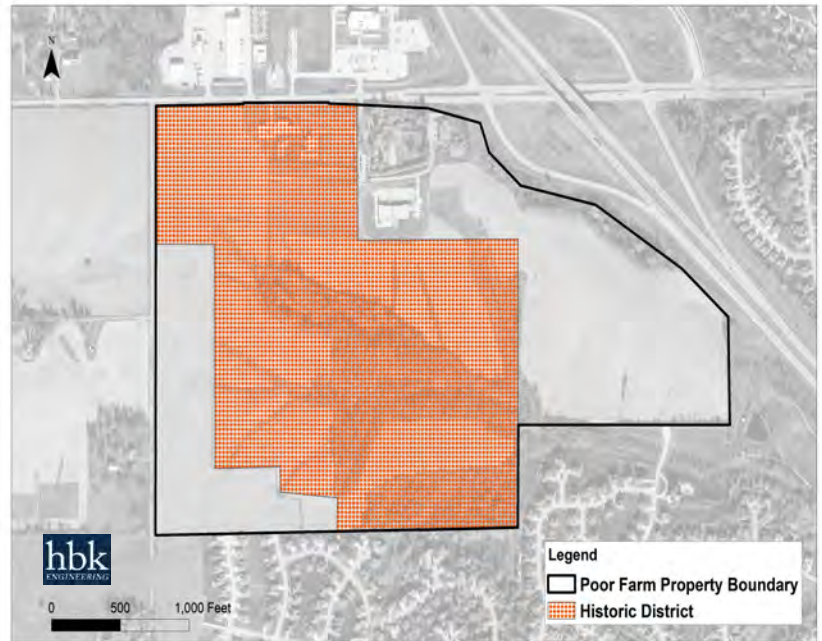

## Land Use Principles

The master planning process has been guided by eight land use principles, which speak to current and future use of this public space. The Johnson County Board of Supervisors are dedicated to the preservation of existing resources, stewardship of the land, and serving the people of Johnson County with new and innovative improvements.

- Preserve Historic District
- Enhance Local Food Production
- Demonstrate a Strong Land Ethic
- Establish a Farm-Incubator Farmstead
- Provide Affordable Housing Options
- Engage Public – Education & Outreach
- Create Sustainable Partnerships

# Stakeholder Engagement and Public Input

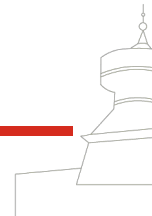

To ensure that the New Century Farm concept implementation could be strategically and successfully done, The HBK team again sought feedback from County staff and local professionals in focus areas of conservation, local food, historic preservation, and affordable housing. Meetings with these individuals allowed the team to add detail to concept components and modify the location of the concepts on the landscape to best serve the public, allow for best land management practices, and efficient maintenance. (e.g. proposed trail alignment for Trail 2 was slightly rerouted to follow a dryer ridgeline, pollinator planting plot designations were modified to account for equipment size, the border for the rotational grazing area was reshaped so fencing and gates would not interfere with trail use).

## Open House

Throughout Phase 1 and Phase 2, the public was able to access information about the project and submit feedback online through the Johnson County Board of Supervisors' website. The public was invited to an open house to view proposed plans for the Johnson County Historic Poor Farm on October 10th at the Iowa City Robert A. Lee Recreation Center from 4:30pm - 8:30pm. All presentations to the Board of Supervisors were public and audio/video is available in the archives of the County website.



### Written Comments at Open House Event:

"Make this happen! Would be a place of pride. Reconstruction of this historic farm into a thriving beacon of healthy soil and food prosecution. Community engagement is key! Housing+ Trails+ recreation along with the sustainable ag components would put Johnson County values on the map!"

"A herbaceous inventory of the forest should be done to see if the site is a remnant savanna or could be restored as one given it's history (e.g. not cropped, grazed, with large oak trees)."

"It doesn't seem right to include housing in the plan. Historic preservation, trails, and pollinator support areas seem right. Signage plan sounds good."

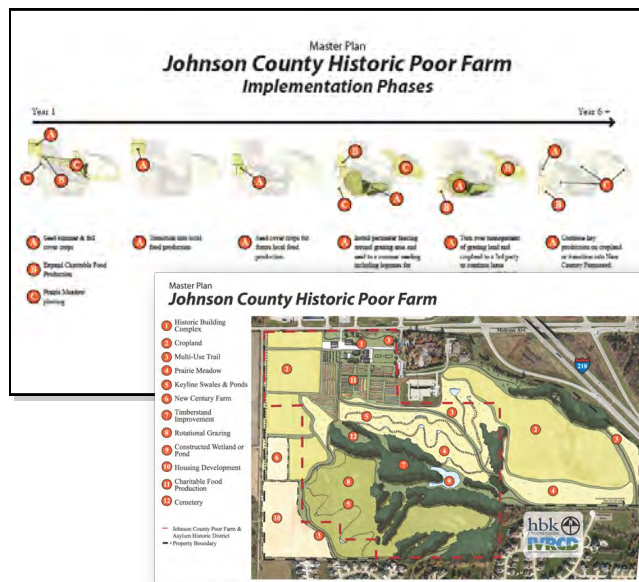

Public Open House boards displayed the New Century Farm Concept, the proposed phasing of land use, an aerial of the Iowa City Greater Area, and the signage package developed by Confluence Landscape Architecture & Urban Design. There were also boards provided on which individuals could write comments regarding the concept and proposed plan elements.

# Stakeholder Engagement and Public Input

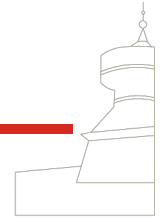

## Troy Gardens

Johnson County Board of Supervisors shared their predilection for the Troy Gardens project during Phase 1 of the master planning process. Troy Gardens is an award-winning, 31-acre project in Madison, Wisconsin which combines community gardens (approx. 300 plots), a five-acre CSA farm, a restored prairie, and a thirty-home, mixed-income, cohousing community. For this reason, on August 14th the HBK Team visited Troy Community Gardens to learn more about the site's history, discuss successes and challenges, and meet with Community Groundworks' staff and project leaders including Executive Director Karen von Huene and the original project developer Greg Rosenberg who is now the Principal at Rosenberg and Associates.

The HBK Team made record of notable differences between the Troy Gardens project and the Historic Johnson County Poor Farm that should be taken into consideration when comparing the two:

- The 31-acres for Troy Gardens is owned by Madison Area Community Land Trust with 99-year leases to Community Groundworks and the cohousing, as opposed to the Johnson County Historic Poor Farm which is County-owned.
- The housing at Troy Gardens is 100% owner-occupied with 80% meeting the criteria for affordable housing. Leased housing is the only option for housing at the HPF, affordable or otherwise.
- There are no contractual ties between the housing on-site and the garden/farm plots, as opposed to options discussed for the Johnson County Historic Poor Farm where a farmer can hold leases for both land and housing.



Aerial drawing of Troy Gardens included with permission

Programming at Troy Gardens is very significant and facilitated by Community Groundworks, the active nonprofit organization. This is similar to how charitable food production efforts have been operating at the HPF in so far as they are connected to nonprofits, actively pursue funding opportunities, and facilitate their own events on site.

To accomplish their goals, which includes but is not exclusive to the Troy Gardens site, Community Groundworks employs two full-time staff and several seasonal part-time staff. Community Groundworks' staff shared that over the years challenges have included access and fees for water infrastructure, vandalism on secluded areas of the site, and consistent hurdles with municipal land use ordinances and processes.

# Current Uses

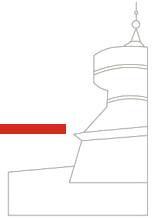

The uses of the Johnson County Historic Poor Farm remain the same in Phase 2 as they were during Phase 1. On site are the Chatham Oaks and Melrose Ridge Apartments, the Joint Emergency Communications Center for Johnson County, and historic Poor Farm buildings. The Johnson County Historical Society offers “Historical Society Poor Farm & Asylum Tours” by appointment. A hundred and fourteen acres are in an agricultural lease. Seven acres are leased for charitable food production (Grow: Johnson County and Iowa Valley Global Food Project).

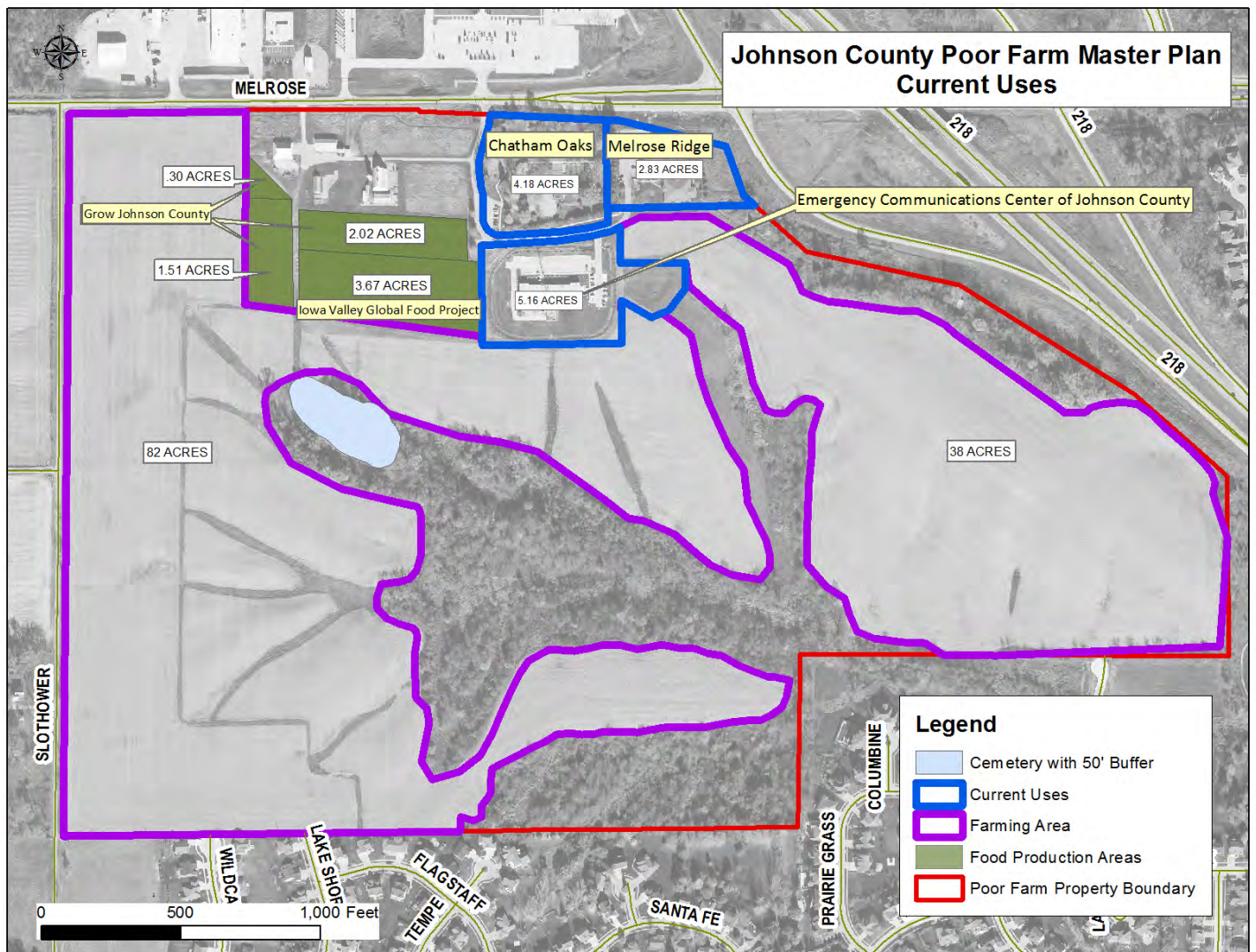



# Woodland Inventory

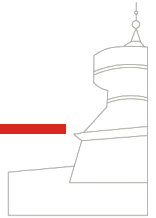

In May of this year, Earthview Environmental conducted an on-site woodland inventory. For analysis purposes the woodlands were delineated into three separate areas: Northern Woodland (approx. 5 acres), Central Woodland (approx. 25 acres), and South Woodland (approx. 9 acres). See the map below for locations.

Historically this area was a tallgrass prairie with the establishment of the woodland areas being a fairly recent addition to the site. Aerial photography shows tree stands becoming established in the 1960's with the majority of the species proliferating into the 1990's.

There are a few significant woodland species noted in the report, such as the oak presence in the Central Woodland and large maple trees in the North Woodland. Additionally, the presence of aggressive understory species are noted throughout all three woodlands, including garlic mustard, Canadian thistle, and reed canary grass. Overall, Earthview Environmental concludes, "Most of these woodland areas are low-quality, early successional areas. However, as described, some notable areas of elevated diversity exist within the site".

See Appendix A for the full report.

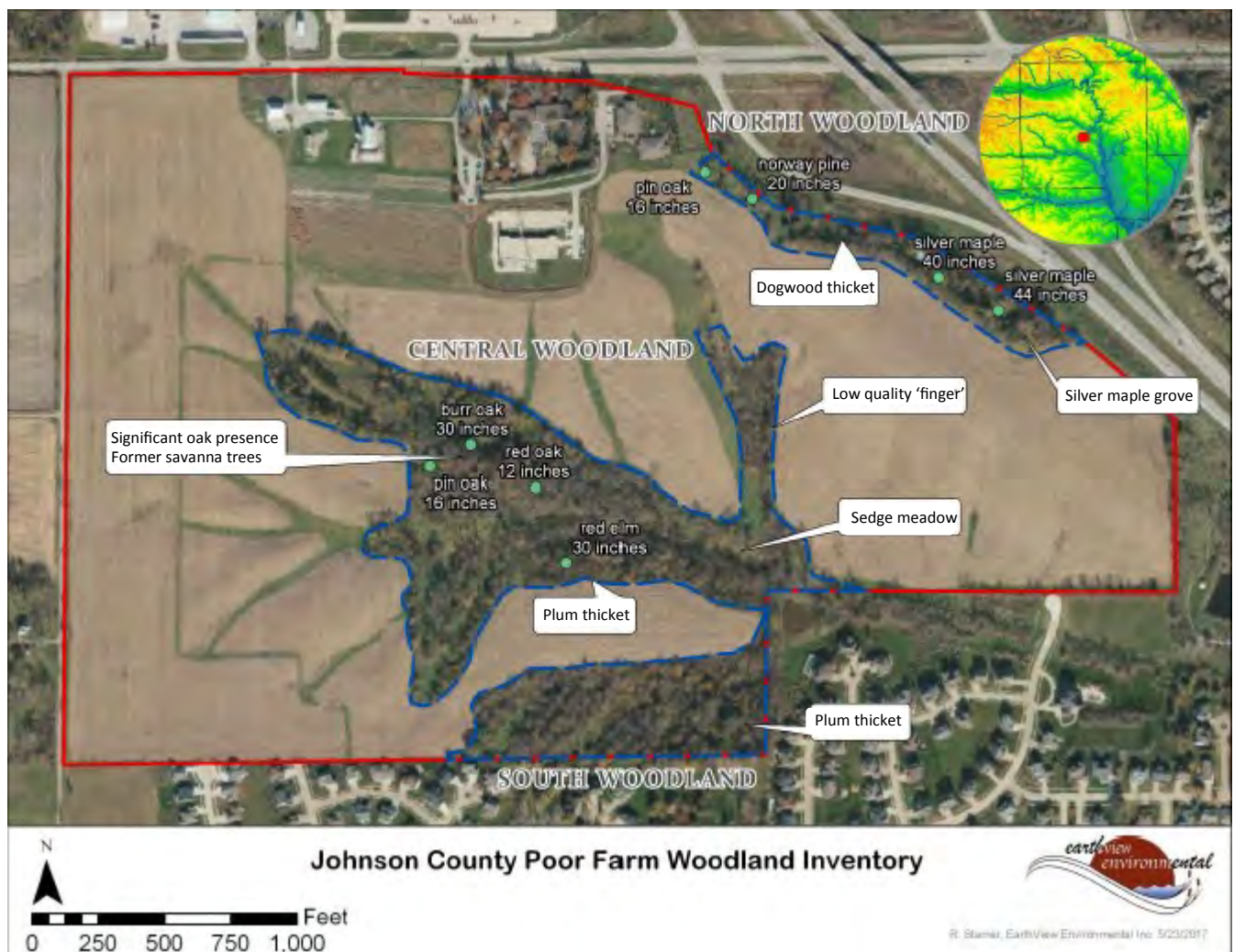

# Signage Packet

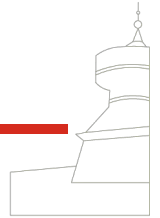

Confluence Landscape Architecture & Urban Planning worked during Phase 2 to determine a compatible signage family for the HPF site. This signage packet includes designs for an entrance monument sign, historic architectural interpretive signage, and wayfinding signs throughout to direct the public to buildings, parking, trails, and restroom facilities.

Together with the HBK Team, Confluence met with the Johnson County Historical Society, the Johnson County Historic Preservation Commission, County Staff, the Office of the State Archaeologist's Burials Program, professional historians and archaeologists, as well as County Staff. Groups shared their preferences and feedback. To offer a wide range of options, examples shown were from across the United States (e.g. historic building signs in small, rural communities and national park signage) as well as some international examples (e.g. small trail markers from public lands in Japan).

Confluence designed prototypes for each category of signage: Monument, Pedestrian, and Interpretive. These drawings were presented to and approved by the Board of Supervisors. Included in the signage packet are estimated costs for each signage type. The signage packet is included in Appendix B of this plan.



**Left:** Current signage indicating locations of Chatham Oaks, Melrose Ridge and JECC.

**Above:** Proposed location for entrance monument sign.

# Housing Development Options

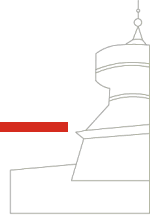

A majority of the Johnson County Board of Supervisors chose the New Century Farm Concept, in part because it aligns with the historic uses of the site. Originally intended to house and care for the mentally ill and low-wealth citizens of Johnson County, this site will also include the opportunity to provide affordable housing options. There is a significant need for affordable housing in Johnson County and the HBK Team researched options and met with affordable housing developers to gain an understanding of the intricacies for providing such a valuable resource. There is a strong desire to include land leases for farmers participating in the farm incubator program and this will be further investigated through the County’s legal department.

In August, the HBK Team met with Maryann Dennis, Executive Director, and Barbara Bailey, Finance Manager for The Housing Fellowship, located in Iowa City and serving all of Johnson County. During this meeting they outlined affordable housing options that the County can pursue given that they want to own the land and the houses must be historically complimentary with regards to the adjacent historic district. The Housing Fellowship has developed housing projects that can meet both of these criteria. They have worked with leading, local architects, such as John Shaw, who was a project partner in Phase One of this plan, and they have developed affordable rental housing by utilizing the Federal Low-Income Housing Tax Credits (LIHTC) program, and a Community Land Trust. A detailed outline for these options is located in Appendix C.

## LIHTC program

In this tax credit program, Federal tax credits are allocated to each state based on population, then each state finance agency drafts a plan that describes criteria for governing the competition for the credits, developers apply for the credits, and if awarded, the developer finds investors to purchase the credits (through a syndicator), the investor offers equity to the project in exchange for credits. In this case, the LIHTC equity provides ~60-70% of the projects financing with 20% coming from private debt and the remaining financing coming from other subsidies. The homes must remain affordable for 30 years as a rental home to low-income households and residents must be below 60% of the HUD established Area Median Income.

## Community Land Trust

A Community Land Trust (CLT) legally separates ownership of the land and improvements. The ownership of the land is retained by the CLT and the homes and improvements are sold at an affordable price to an eligible, qualified homebuyer. Then the homeowner enters an extended lease (typically 99 years) to the CLT, taking the cost of the land out of the equation for the expense of purchasing a home. If the County creates a CLT and retains the land, this would allow affordable homeownership to take place instead of leased housing.

EXAMPLE OF TAX CREDIT PROJECT				
Incomes must be either 40% AMI or 60%AMI. Rents at \$704 or \$906 (3 Bedroom)				
Household Size	40%	Hourly Wage	60%	Hourly Wage
3	\$28,625	\$13.76	\$42,960	\$20.65
4	\$31,800	\$15.29	\$47,700	\$22.93
5	\$34,350	\$16.51	\$51,540	\$24.78
6	\$36,900	\$17.74	\$55,380	\$26.63

Master Plan

# Johnson County Historic Poor Farm

- 1 Historic Building Complex
  - 2 Cropland
  - 3 Multi-Use Trail
  - 4 Prairie Meadow
  - 5 Keyline Swales & Ponds
  - 6 New Century Farm
  - 7 Timberstand Improvement
  - 8 Rotational Grazing
  - 9 Constructed Wetland or Pond
  - 10 Housing Development
  - 11 Charitable Food Production
  - 12 Cemetery
- Johnson County Poor Farm & Asylum Historic District
  - Property Boundary

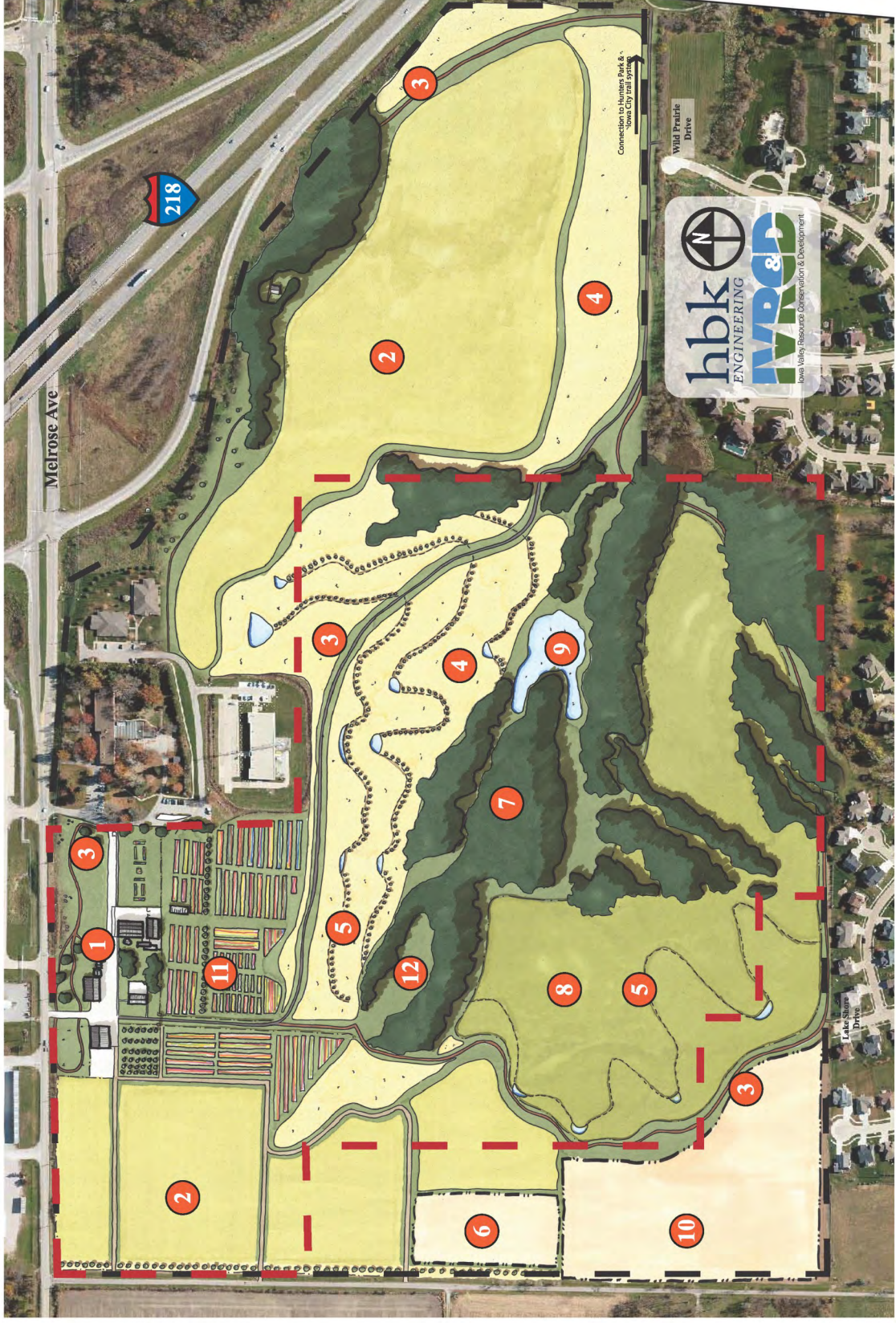

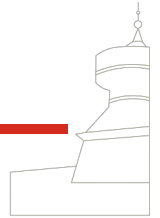

The New Century Farm Concept is a vision for the site that preserves its history, better serves the public through farmland access and recreation, and demonstrates a strong land ethic through active management and conservation. Each of the concept elements has been further vetted by professionals in their respective fields.

## 1. **Historic Building Complex**

This area includes the West Barn, Dairy Barn, and Asylum Building as well as other noncontributing buildings. It is currently the primary access point for the site. Preservation and restoration of the structures as well as improved access between buildings is a priority. See pages 11 and 12 of this report for details about this area.

## 2. **Cropland**

Crops selected for these areas will ideally fit market demands. Access and acreage will best suit smaller scale equipment. Once established, The New Century Farm managing entity can oversee the contract(s).

## 3. **Multi-Use Trail**

There are three trails included in this concept. Preliminary discussions have each trail 10' wide with most of the trails lengths consisting of crushed limestone. There are certain sections of the trails that can be made of harder surface materials in order to facilitate ADA accessibility. The first trail slated for implementation is the central trail that begins in the Historic Building Complex and connects to Hunters Run Park. This trail will have a trail head marker in the Historic Building Complex and provide pedestrians with an opportunity to walk along the edges of food production areas, a pollinator plot and down along through farmland to then continue on to an Iowa City park.

## 4. **Reconstructed Prairie/Pollinator Plots**

The seed mixes and planting schedules for these areas will be determined by natural resource professionals at Johnson County Conservation during implementation phase with considerations for available/existing seed resources, funding opportunities, pollinator species' plant preferences, soil type, trail alignment, and aesthetic.

## 5. **Keyline Swales & Ponds**

This is a practice that is used to capture stormwater to improve the soil and provide water to fruit/nut trees and shrubs. Water collects in swales and small detention basins and slowly saturates subsoil layers while increasing soil formation. Swales are designed to only hold water for a brief amount of time after rainfall.



## 6. **New Century Farm**

The New Century Farm is the namesake of this concept and it is also the on-site effort to create new farming opportunities. This “New Century Farm” can be run by a third-party entity determined in the future. The area on the concept map for this element is identified as a site where new farm buildings could be erected outside the Historic District. These possible structures (e.g. a new barn, storage shed, hoop house, etc.) fit an original purpose of the site maintained - farming.

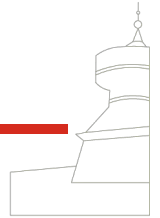

## **6. Timberstand Improvement**

The woodlands would benefit from TSI. Considerations could also be made to complete an herbaceous inventory in case there are remnant savannah/prairie species remaining.

## **7. Rotational Grazing**

The pasture area designated for rotational grazing could be managed through a lease agreement with an area farmer or by the manager for the New Century Farm. Temporary fencing would be used to facilitate regular rotations of the livestock. (Permanent perimeter fencing secures the overall area.)

## **8. Wetland or Pond**

This low area could be managed to better hold water onsite. A constructed wetland or pond is an option for this area due to a high water table and soil type. This water body would not be for recreational use.

## **9. Housing Development**

This element will require significant review before being implemented. The current intent is to provide affordable rental housing options that respect the historic district aesthetic and viewshed. Leases could also include land leases for farmers in the incubator program; however, this aspect needs to be further investigated. The HPF is located with Iowa City limits and the proposed development area is zoned Public 1 (P1), which will require a re-zoning process with the city. The rezoning process includes a full site plan with all development aspects included and an analysis of sensitive areas, archeologic review, and good neighbor meetings. This process for a development of this size (16 acres), historic nature, and leased housing mandate could take up to a year, with the affordable housing elements adding another layer of legal inquiry and application timing. A preliminary housing development investigation resulted in options outlined in Appendix C.

## **10. Charitable Food Production**

This area is currently being leased by Grow: Johnson County and the Iowa Valley Global Food Project. Production is expected to expand based on current interests and resources.

## **11. Cemetery**

The cemetery is a highly sensitive area that will be given a wide buffer. Discussion regarding the best way to maintain, honor, and mark this site should continue beyond Phase 2. There are recommendations to remove small saplings from the site and any large dead trees along the perimeter, place a stone marker at the entrance, and have a small trail that leads to the entrance off of the main trail.

# Johnson County Historic Poor Farm

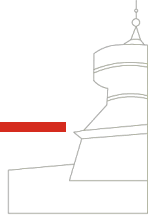

[This page intentionally left blank]

# Johnson County Historic Poor Farm Master Plan Historic Building Complex



Melrose Ave

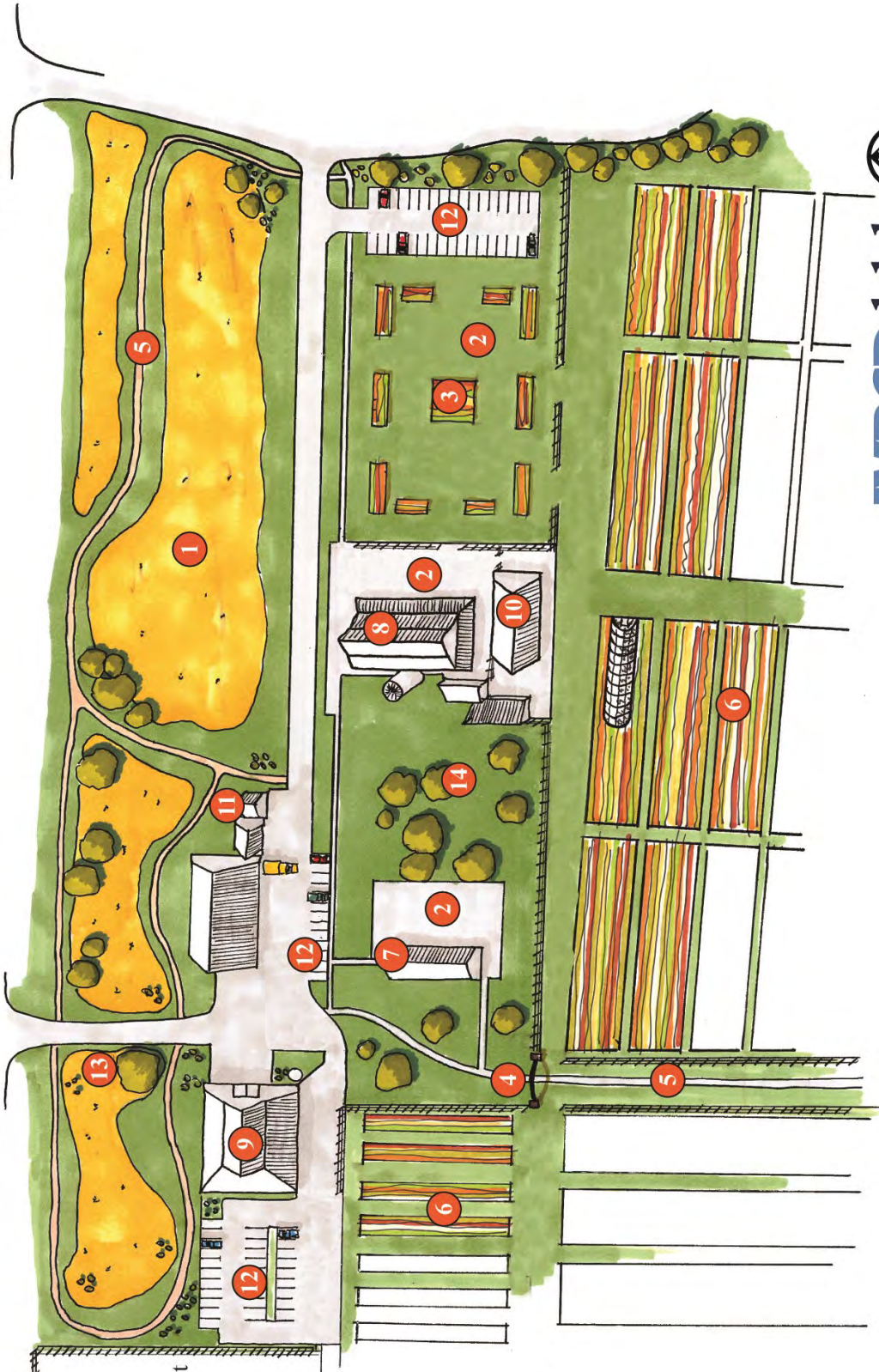

- 1 Reconstructed Prairie
- 2 Public Picnic Area
- 3 Coloring the Landscape Project
- 4 Trailhead
- 5 Multi-Use Trail
- 6 Charitable Food Production
- 7 Historic Asylum
- 8 Historic Dairy Barn
- 9 Historic West Barn
- 10 Newly Constructed Pole Barn
- 11 Public Restrooms
- 12 Parking
- 13 Entrance Sign
- 14 New Tree Plantings

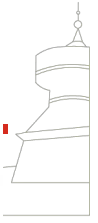



# Historic Building Complex

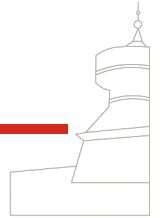

The Historic Building Complex encompasses all of the buildings on the National Register for Historic Places as well as open space, the Coloring the Landscape project, and local food production areas. This area has already seen an increase in visitors this year with the Johnson County Historical Society reportedly conducting 170+ tours of the Asylum building and adjacent historic area, and charitable food production initiatives reporting more than 300 visitors. During Phase 2 several large events occurred on the site which gave the HBK Team a chance to see how the public interacted with the site as it exists today. This area will see the greatest increase in use in the next five years. Recommendations are:

1. **Reconstructed Prairie**

Enhance this open space aesthetically and increase diversity.

2. **Public Picnic Area**

The concrete in this area is broken and collapsing. People naturally gather here and it is slated for interpretive signage that will attract more attention. Improve the concrete and add picnic tables.

3. **Coloring the Landscape Project**

This is a historical agricultural project that first appeared in the Johnson County Historical Society's 2001 newsletter and is discussed in more detail on page 20 of this report.

4. **Trailhead**

The signage packet includes a trailhead marker.

5. **Multi-Use Trail**

This trail will be the first trail created on the site and connects to Hunter's Run Park.

6. **Charitable Food Production**

These areas being used currently are well-suited for fruit and vegetable production and should remain designated for this purpose as long as there are viable partners.

7. **Historic Asylum Building**

Listed on the National Register of Historic Places, this building is actually one wing of the original asylum building that housed patients. Tours are given upon request.

8. **Historic Dairy Barn**

Standing as a reminder of the previous dairy operation, the Dairy Barn still has milking stanchions on the first floor and a haymow on the second story loft.

9. **Historic West Barn**

This monitor-roofed stock barn was built around 1902 and supported the dairy operation as a feeding area with an in-ground brick cistern inside.

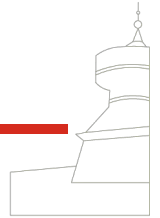

- 10. Newly Constructed Pole Barn** This is a place for storage of tools and vegetables that provides much needed shelter for the agricultural operations currently on site. A new structure is needed.
- 11. Public Restrooms** These restrooms currently exist and will need a few upgrades, such as a diaper-changing table and a water filling station.
- 12. Parking.** Due to the expected increase in public visits to the HPF site, parking will need to be delineated. To preserve the historic character of the site, much of the parking will be located on the perimeter of the site, with a few parking spots located adjacent to the Asylum building to provide ADA access.
- 13. Entrance Sign.** One of the first items slated to be constructed, this entrance sign will welcome visitors onto the HPF site.
- 14. New Tree Plantings.** To provide a welcoming place for visitors to enjoy the site, trees will be planted here to provide shade and respite from the natural elements.

It should also be noted that access throughout the site will be investigated further with the assistance of City and County Staff, as well as professional archaeologists. While our team recommends upgrading the impermeable surfaces, such as the roadway, parking, and sidewalk infrastructure, we do want to remain sensitive to the historic significance of the site. Providing public access to the site while maintaining and strengthening the historic aspects is a tricky balance; however, it is of highest priority that this be accomplished.



Current parking infrastructure is inefficient and potentially hazardous. These pictures were taken during a large event where cars parked in areas that could lead to a public safety hazard. Note the fire hydrant in the picture on the left, and the perpendicular parking in a parallel space on the right.

# Johnson County Historic Poor Farm

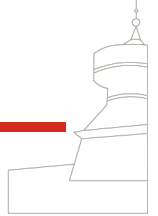

[This page intentionally left blank]

# Priorities

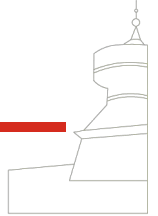

One of the main goals of Phase Two is to generate prioritized short and long-term projects over the course of the next decade. These project priorities align with the Land Use Principles outlined on page two of this plan and are meant to serve as a roadmap for the Historic Poor Farm site. Based on the underlying principle that the land remain open to the public, these priorities unfold over the years in an effort to create an experience that reminds us of what was once there and provide a vision for the future.

The first few years are focused on creating an inviting public space to the Historic Building Complex. To accomplish this goal, we have prioritized signage, historic preservation, and local food improvements. The subsequent years will incorporate changes to the larger landscape, such as planting cover crops to prepare the soil for expanded farm production, creating pollinator plots, constructing trails, and eventually developing housing. These larger projects will be conducted in concert with market demands for farm products, housing markets, and potential partnerships with local and regional stakeholders.

The pie chart below provides an estimated budget for resources that will be allocated in the first five years of implementation. Any grants secured will provide additional resources that could result in an accelerated timeframe for certain projects.

## Budget Allocations for Improvements First Five Years

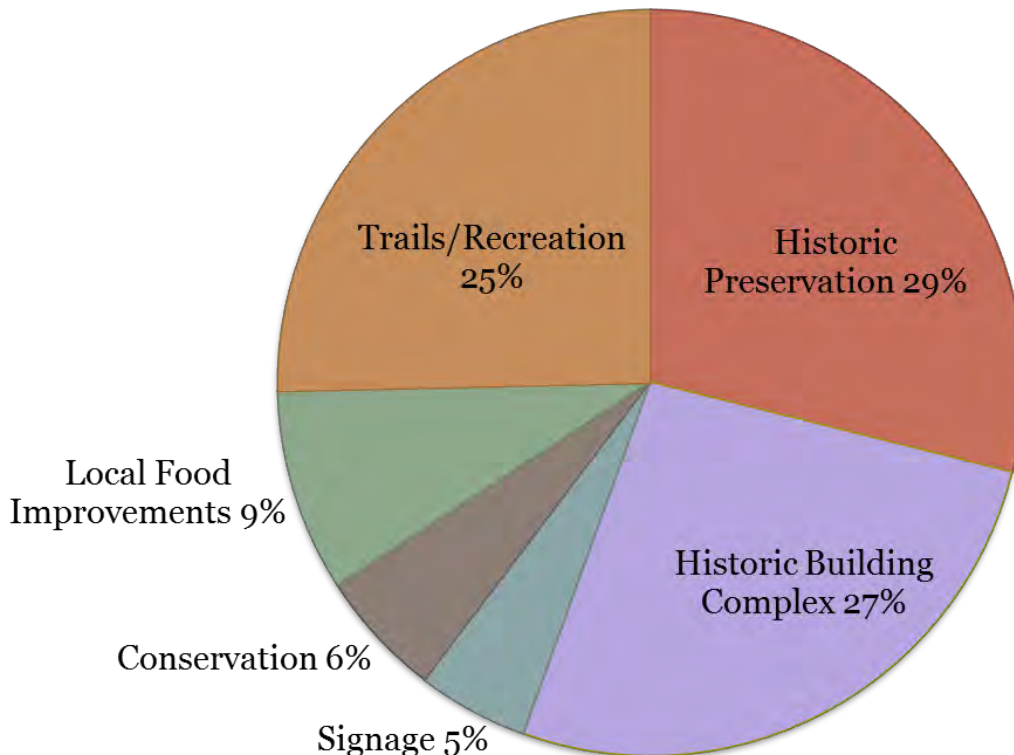

# Short-Term Priorities - Year One

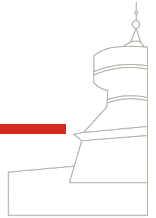

Year One will be a building year for the HPF site, in more ways than one. There are infrastructural improvements that will be implemented and programmatic elements that will be cultivated. Activities in the first year will set the stage for projects in years two, three and four.

## Land Use Changes

In order to support the local food production goals of the site, summer and fall cover crops will be planted in the northwest corner of the site.. A large pollinator plot will be established adjacent to the food production sites and the charitable food production area can be expanded.

## Year One Improvements

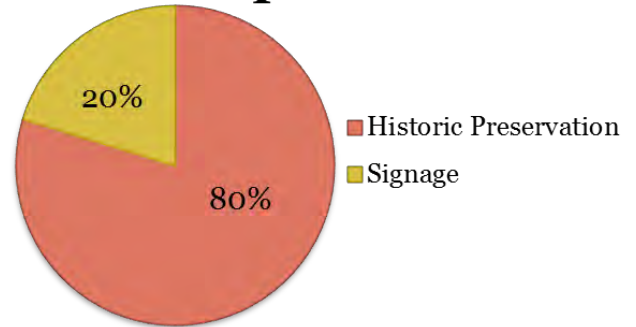

## Signage

Currently there the HPF is difficult to find because there is no entrance signage marking the site. The absence of this entrance marker causes confusion for people signed up for tours of the Asylum Building or coming to volunteer at the non-profit food production areas. Additionally, there are no markers located on the highway or leading up to the HPF to direct traffic from the east or west on Melrose Avenue. County staff secured a Silos and Smokestacks grant that will assist in funding the placement of the entrance sign in the first year of implementation.

## Management

As important as it is to establish infrastructural improvements it is equally important to establish managerial roles and responsibilities for the site. In this first year it will be imperative for the success of the implementation phase to establish and implement a matrix of responsibilities. This matrix will include all entities that are involved with the HPF and will outline their roles and responsibilities. In addition to this matrix, a flow chart of communication will be created with the Poor Farm management organization serving as the one point of contact for all entities. These two items, the Matrix of responsibility and the Communication Chart will clarify roles and responsibilities for everyone and provide a method for communication.

## Programming

Once roles and responsibilities are clarified. programmatic elements will be explored to strengthen partnerships with county-wide municipalities, local agencies, educational institutions, hospitals, and the wealth of non-profit/advocacy organizations located throughout Johnson County. It is the role of managing organization to conduct outreach and education about the HPF and pursue partnerships to further the goals of the site.

# Short-Term Priorities - Year Two

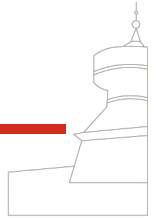

In year two the emphasis remains on the historic preservation of the farm structures, especially the West Barn.

Considerations can be made for additional signage on site (e.g. wayfinding purposes).

Access improvements can be made or be better designated. This may mean better pathways throughout the site or simply better use delineation with discrete fencing around local food production.

To continue supporting local food production efforts, it is recommended that the South Storage Shed be replaced with a similar building. This new building should maintain the historic agricultural aesthetic.

Cover crops will be planted in areas slated for expanded food production. Additionally, smaller pollinator plots will be expanded.

## Year Two Improvements

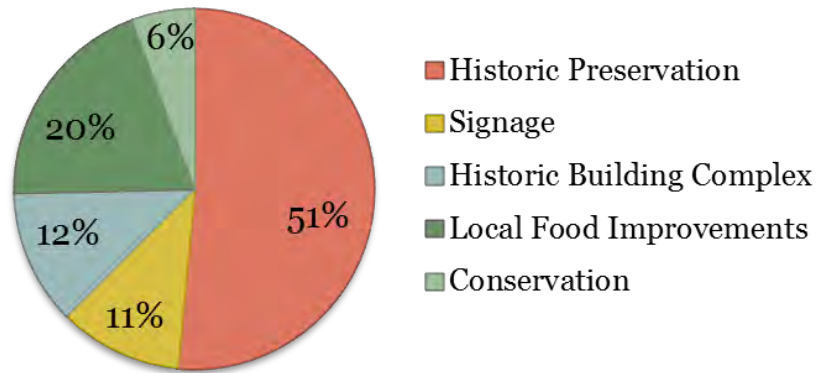

### Historic Preservation

Stabilizing West Barn

### Signage

Wayfinding

### Historic Building Complex

Sidewalks, Concrete Improvements

### Local Food Improvements

South Storage Shed, Cover Crops

### Conservation

Pollinator Plots



## Short-Term Priorities - Year Three

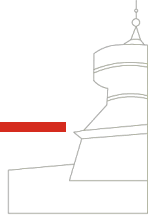

Year three sees a continuation of historic preservation with majority of resources being allocated to the Dairy Barn building. This building, stabilized in recent years, is stable; however, peeling paint in the large first-floor room where the dairy stanchions are located should be addressed. An evaluation should be done to determine whether lead abatement needs to occur.

### Year Three Improvements

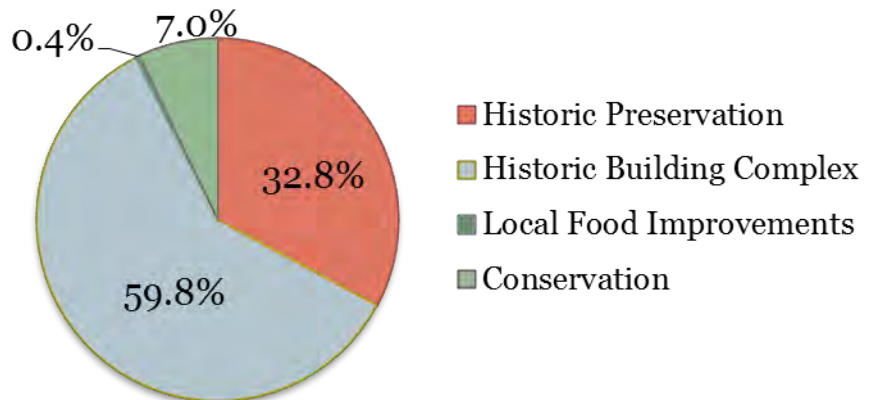

Efforts should also be made to remediate interior issues of the Dairy Barn to provide further public access opportunities to this building.

It is recommended that resources available following the Dairy Barn improvements be allocated to The Historic Building Complex. Priorities within this complex are a 10' wide, crushed limestone nature pathway throughout the vegetated area adjacent to Melrose Road that connects to Chatham Oaks, improvements to the concrete surrounding the Asylum Building/Dairy Barn to reduce tripping hazards and improve public safety, a water-filling station, and baby-changing station in the public restroom.

Local Food Improvements will include planting cover crops in areas slated for food production in the following year, as well as the expansion of small pollinator plots.

#### Historic Preservation

Improvements to Dairy Barn

#### Historic Building Complex

Nature Trail, Concrete Improvements, Public Amenities

#### Local Food Improvements

Cover Crops, Soil Restoration

#### Conservation

Pollinator Plots



# Short-Term Priorities - Year Four

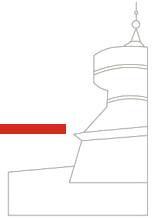

Year four recommendations remain largely within the Historic Building Complex. New fencing and gates should be installed to create spaces for pedestrians to visit while protecting farming areas from becoming trampled/damaged. Considerations could be made for installation of public art.

The shed along the north side of the Historic Building Complex currently houses a large refrigerator that is being utilized by GROW: Johnson County with the intention that this shed could be further outfitted to store more vegetables and fruits that are grown on site. Additional considerations could include bike lockers and bike racks for those that want to commute to the site by bicycle or potentially utilize the trail system. Another water well will also need to be installed on the western side of the site to facilitate irrigation for crops.

Conservation efforts will continue with the planting of prairie grasses/pollinator species on the eastern half of the site.

The first trail will be installed through the central part of the site, connecting the Historic Building Complex to Iowa City’s Hunters Run Park.

## Year Four Improvements

### Historic Building Complex

Fencing/Gates, Historic Public Art

### Trails/Recreation

North Shed, Additional Well, Fencing

### Conservation

Prairie Grasses

### Trails/Recreation

Trail #1

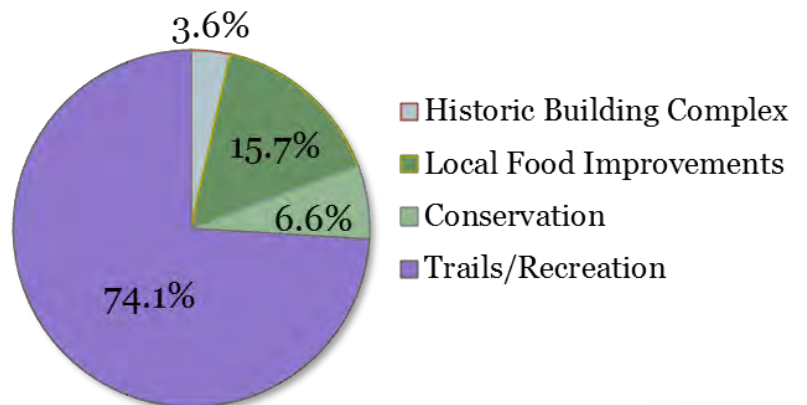



## Short-Term Priorities - Year Five

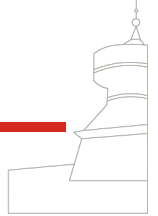

Year five is centered on expanding recreational and conservation opportunities. This year will see the second trail built on the eastern side of the site. Continuing the existing trail that currently begins near the Melrose Ridge apartments and extends south along the highway, this trail will extend all the way to Hunters Run Park. There is a park shelter in the Northern Woodland area and the current trail reaches this structure. By continuing this trail, apartment residents and trail-goers will be able to enjoy the park shelter and link to the Iowa City Parks System.

In order to continue the stormwater best management practices that the County currently pursues, bioswales and raingardens will be installed within the Historic Building Complex. These practices capture stormwater runoff from adjacent impermeable surfaces (roadways, rooftops, etc.) and offer a place for the water to pool and slowly percolate, reducing erosion damage and recharging aquifers. Additional benefits include the aesthetic appeal of the plants and flowers that are grown in these practices, which can also serve as attractive plants to pollinators.

## Year Five Improvements

### Trails/Recreation

Trail #1

### Conservation

Bioswales, Raingardens, Soil Restoration

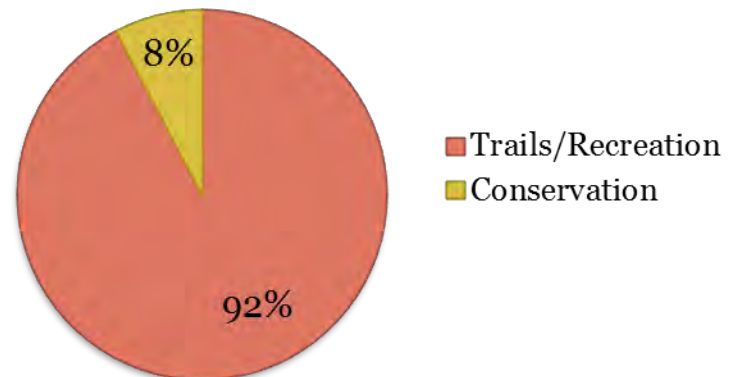

Raingarden before and after picture. Source: [Johnson County Soil and Water Conservation District](#)

# Long-Term Priorities - Years Six and Beyond

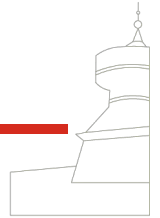

Looking out past the first five years of implementation, there are several opportunities to continue supporting historic preservation, local food production, and land stewardship on the HFP site. All of these elements will need to be explored further, however, they are included in this plan as necessary components for the long-term vision of the HPF site:

## Historic Building Complex

Coloring the Landscape Project,  
Renewable Fuel/Energy Options

## Trails/Recreation

Continue Trail Completion, Trail  
Under Hwy 218, Park Shelter

## Local Food Production

New Century Farm, Farm Entrances

## Housing

Affordable Housing & Farm  
Incubator Housing Leases

The Coloring the Landscape project began as an initiative that was included in the Johnson County Historical Society's newsletter in 2001. The plan creates three food production plots that represent three separate periods in Iowa's history:

- A Native American demonstration that showcases agricultural practices, product varieties, harvesting, preparation, and storage techniques used in this region prior to settlement.
- A Johnson County Historical Poor Farm representation of the food management circa 1875 that former residents would have experienced.
- A Modern Market Garden that showcases the local food systems movement, and the benefits they provide to local Farmer's Markets and area restaurants.

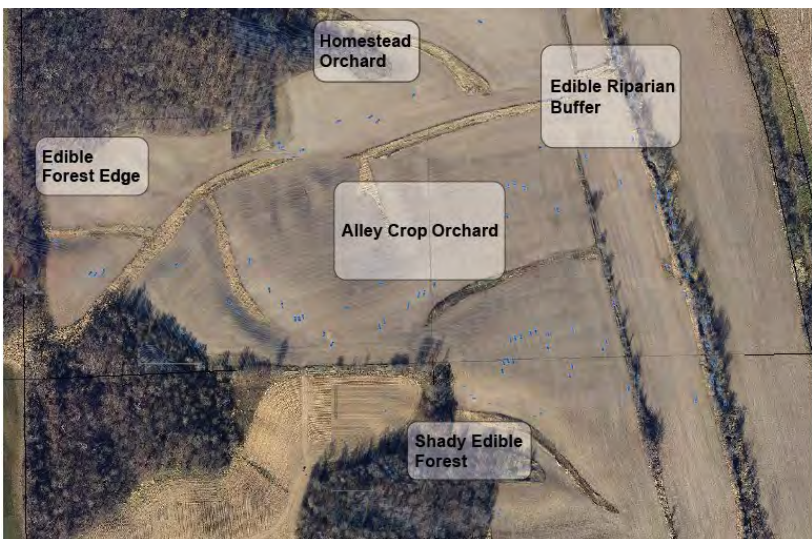

An Alley Crop Orchard is an agroforestry practice that plants agricultural crops between strips of food-bearing trees and shrubs. Utilizing agroforestry methods, local food production can be enhanced on the HPF site to increase results while providing benefits to the soil by reducing erosion.

Image taken from Backyard Abundance: "[Edible Agroforestry Design Templates](#)".

# Johnson County Historic Poor Farm

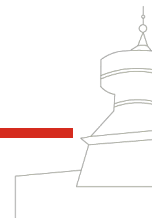

[This page intentionally left blank]

Year 6 +

Year 1



- A** Seed summer & fall cover crops
- B** Expand Charitable Food Production
- C** Reconstructed Prairie/Pollinator Plot



- A** Transition into local food production



- A** Seed cover crops for future local food production



- A** Install perimeter fencing around grazing area and seed to a summer seeding including legumes for grazing.
- B** Transition into local food production
- C** In the fall plant a small grain on the remaining crop ground. Under-seed the small grain with alfalfa and forage mixes for future hay production.



- A** Turn over management of grazing land and cropland to a 3rd party or continue lease agreements with local food producers.
- B** Harvest small grain crop in summer and transition into hay production.



- A** Continue hay production on cropland or transition into New Century Farmstead.
- B** Continue hay production on cropland or transition into housing.
- C** Install key line swales, trails and fruit & nut plantings. Timberstand improvement.

# Cropland Phasing

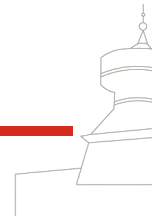

The Historic Poor Farm has long been a working landscape dedicated to farming. The proposed phasing detailed below is an effort to gradually and strategically transition the 100+ acres of traditional rowcrop agricultural land into smaller garden/working plots. This phasing results in a more dynamic patchwork of land use, increases the acreage of perennial vegetation, expands onsite charitable food production, and favors small/beginning farmers.

The following changes to the landscape are proposed:

**Year 1.** Plant pollinator meadow and seed NW quadrant into cover crops for future local food production. Expand charitable food production

**Year 2.** Transition NW quadrant into local food production

**Year 3.** Seed cover crops on future local food production land in the central part of the western section of the property.

**Year 4.** Install perimeter fencing around grazing area and seed it to a summer seeding including legumes for grazing. Transition central portion of western boundary into local food production that was in cover crops in year two.

After crops have been harvested in the fall of year 4 plant a small grain on the remaining crop ground. Under-seed the small grain with alfalfa and forage mixes for future hay production.

**Year 5.** Turn over management of grazing land and cropland to a 3rd party or continue lease agreements with local food producers. The small grain crop would be harvested in the summer of the 5th year and begin hay production.

**Year 6 and beyond.** Continue hay production on past cropland or transition hay ground into New Century Farmstead and/or housing.



Photo Courtesy of Iowa Valley RC&D

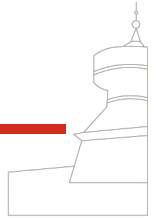

With few historic poor farms left in Iowa and around the nation, Johnson County has a unique opportunity to preserve and honor important history as well as serve the public through thoughtful and innovative onsite improvements and investments. In the next few years, as work is done to implement New Century Farm plan elements, signage will be installed and partner events will increase in frequency and size. The site will become more familiar to the public both within and outside of Johnson County.

County staff could consider a branding effort that leverages partner activities and highlights onsite improvements. This effort can reinforce the branding and marketing already in place or be more specifically tailored at a project level. Regardless of approach, the messaging should be clear and consistent.

It is the recommendation of the HBK Team that the county consider taking a proactive approach instead of a reactionary approach to telling the story of the site both to ensure a higher level of engagement and to positively influence future funders and future partners. The team recommends that online and print materials echo the branding of the signage family designed by Confluence Landscape Architecture & Urban Design.

“Colors within the signage family are all generated through the natural materials used to construct the signs. Weathering steel, stainless steel, lumber and limestone are all used to create a pallet that responds to the agrarian aesthetic and rustic character of the site. There is not a “traditional” color pallet, but instead a theme generated from the repetition of the colors and textures inherent in each of these materials.” — Confluence

The team also recommends:

1. Quarterly press releases highlighting a current effort/accomplishment.
2. Active and open communication with partners to leverage marketing opportunities
3. A one-page handout about the site that shares the county’s vision and values
4. A small photo library of professional, high quality images for county staff to have available for future grant applications and possible marketing needs.
5. Improving the online presence for the site both aesthetically and in regards to searchability.

A one or two page color handout could help communicate a consistent message about the site to both internal and external stakeholders. It could be available online and in print as needed. A series of several handouts could be done to coordinate with efforts and reach targeted audiences (e.g. Beginning farmers, partners seeking venues for events, etc.)

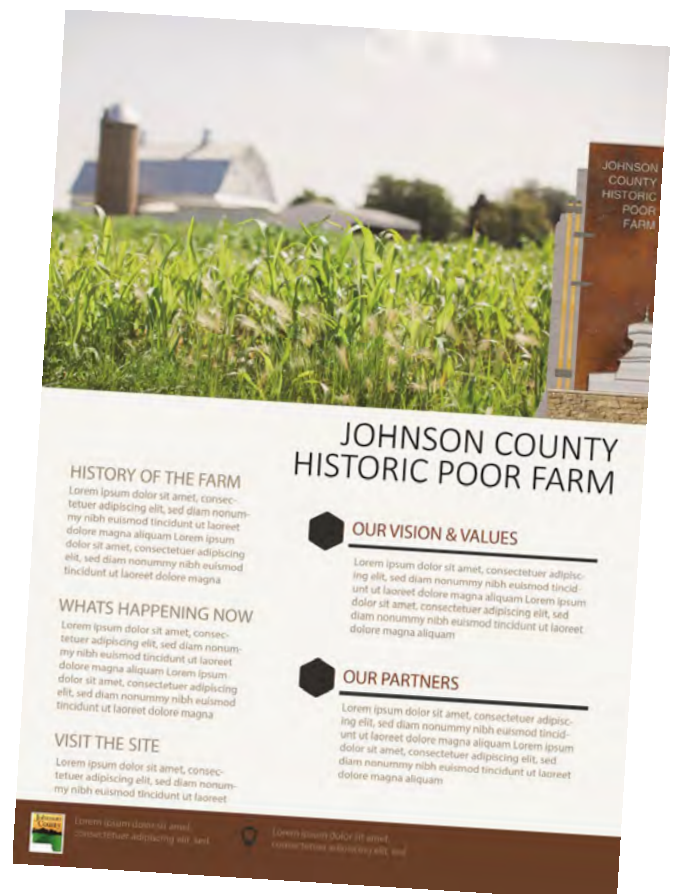

## Phase Three Recommendations

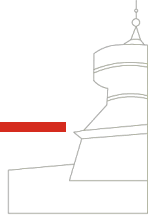

Informed by both Phase 1 and Phase 2, our team has the following recommendations for the Implementation Phase:

### 1. **New Century Farm Concept Implementation Matrix**

A comprehensive matrix which lists New Century Farm components, target timelines, responsible entities, lead contact, possible funding sources, potential partners, etc. This matrix should be available to key internal stakeholders and should be completed at the start of the implementation phase.

### 2. **Management Entity**

Because of both the project complexities and opportunities for strategic success, considerations should be made to have a single entity lead the Implementation effort. The programmatic elements outlined in this plan will necessitate an entity with strong interest in bringing community partners to the table and communicating the wealth of resources that the HPF has to offer. With this in mind, a significant portion of the management will also be spent marketing the HPF to create future opportunities for partnerships.

### 3. **Historic Review**

An archeological review that includes professional vetting of the proposed historical impacts should be a high priority.

As the Johnson County Historic Poor Farm becomes developed these recommendations are intended to provide a smooth implementation phase that will support the gradual and exciting upgrades envisioned for this site. Our team has been honored to work on this planning endeavor and look forward to the anticipated improvements.



Photo Courtesy of Iowa Valley RC&D

## Appendices

---

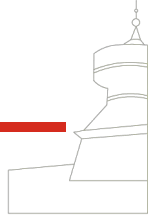

**Appendix A:** Woodland Survey- Earthview Environmental

**Appendix B:** Signage Packet- Confluence Landscape Architecture & Urban Design

**Appendix C:** Affordable Housing Options, The Housing Fellowship



**Johnson County Poor Farm  
Woodland Inventory  
Iowa City, Iowa**

**May, 2017**



**Johnson County Poor Farm  
Woodland Inventory  
Iowa City, Iowa**

**Prepared for  
HBK Engineering**

**May, 2017**  
EVE PROJECT #: HBK-004

**Prepared by:  
Reid Stamer, Restoration Ecologist**

**EarthView Environmental, Inc.  
310 Second St.  
Coralville, Iowa 52241  
Phone: 319-358-2542  
Fax: 319-358-2562  
Email: [EVE@eveinc.consulting](mailto:EVE@eveinc.consulting)**

# TABLE OF CONTENTS

## Contents

1.0 Executive Summary .....	1
2.0 Site Evaluation .....	1
2.1 Methodology .....	1
2.2 Site Summary.....	1
2.2.1 North Woodland .....	2
2.2.2 Central Woodland .....	2
2.2.3 South Woodland .....	2
3.0 Conclusions .....	5
Appendix A: 1930's Aerial Photo.....	6
Appendix B: 1960's Aerial Photo.....	7
Appendix C: Site Photos.....	8
Appendix D: Cumulative Species List .....	12

## 1.0 Executive Summary

EarthView Environmental Inc., (EVE) was contracted by HBK Engineering to complete a woodland inventory for 41 acres of woodland on the Johnson County Poor Farm, in Iowa City, Iowa. The project is located southwest of the Highway 218/Melrose Ave interchange in Township 79N, Range 07W, Section 13 and Township 79N, Range 06W, Section 18 (Figure 1). Within the project area there are three distinct forested areas that will be referred to as North, Central, and South based on their relative locations. With few exceptions, the woodlands are fairly even-aged and low-quality. Each area is described in detail below.

## 2.0 Site Evaluation

### 2.1 Methodology

GIS research was completed prior to visiting the site to determine past land uses, disturbances, and areas of potentially elevated diversity. Analysis included examination of aerial photographs from the 1930's through 2016, and topographic information. The site was walked on 5/22/2017 to document forest cover, including: canopy/sub-canopy, shrub layer, and understory species. A Trimble GeoXH 6000 GPS unit was used to record large trees and unique areas. A cumulative list of species noted during the survey can be found in Appendix D.

### 2.2 Site Summary

According to the General Land Office survey, the entire project area was historically tallgrass prairie. Since European settlement, the area has been used for a variety of agricultural purposes, from pasture to row-cropping, which continued to restrict the establishment of woody species until fairly recently. Currently forested areas lie within and adjacent to wet drainage swales, and were likely found too difficult to farm. As areas were no longer farmed, trees began to establish in the 1960's, although the majority of woody encroachment began in the 1990's.

Higher ridges in the site can be described as even-aged, early-successional forest dominated by white mulberry, ash-leaf maple, with a variety of other early successional hardwoods subdominant, including elm species, and black cherry. The shrub layer is dominated by gray dogwood, bush honeysuckle, and American plum. Common understory species include Canadian honeysuckle, clustered black-snakeroot, and garlic-mustard.

Wet drainage swales are generally fairly open with a sparse canopy of black willow and an understory dominated by reed canary grass with a minor sedge component.

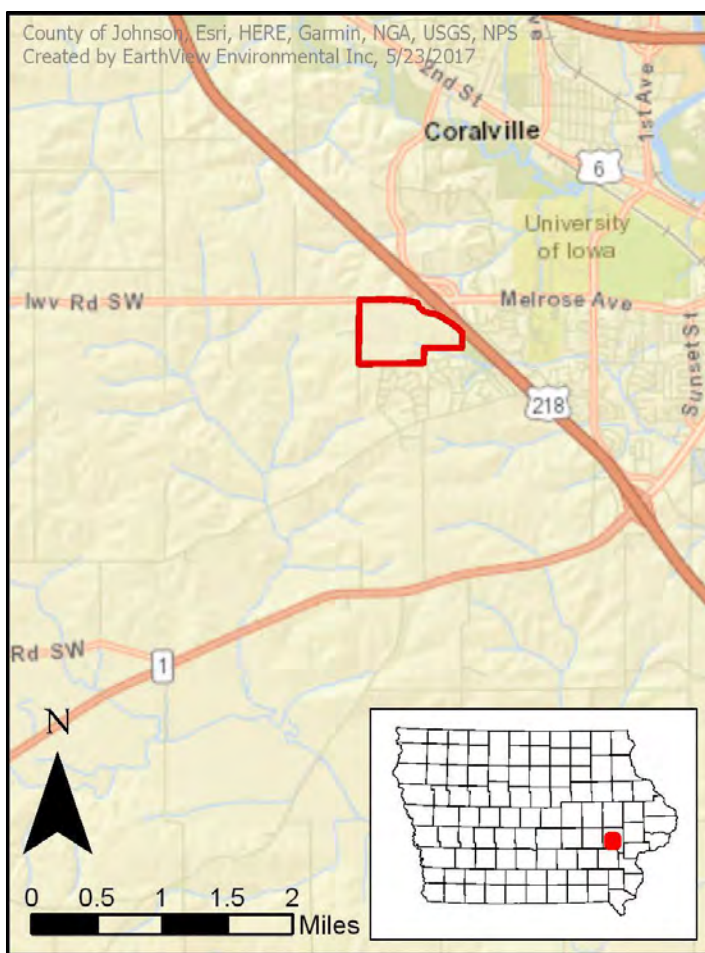

Figure 1: Project Location

### **2.2.1 North Woodland**

The North Woodland is approximately 5 acres located on the northern edge of the project boundary, just south of Highway 218. A single pin oak is located near the northwest corner of this area. The western one-third is dominated by white mulberry, with ash-leaf maple, red pine, and Colorado spruce subdominant. It is likely that the coniferous trees were planted as a windbreak. Trees in this area are generally less than 30 years old and range in size from 16-30" diameter at breast height (DBH). The understory is dominated by smooth brome, reed canary grass, orchard grass, Canadian thistle, and wild parsnip.

Species diversity increases steadily moving southeast, though this area is approximately the same age as the northwestern one-third. The occasional gray dogwood thicket is interspersed with elm, silver maple, eastern cottonwood, black cherry, and eastern red cedar, although white mulberry and ash-leaf maple remain dominant. In the eastern two-thirds, a woodland herbaceous layer begins to develop, dominated by Canadian honewort, clustered black-snakeroot, garlic-mustard, and sticky-willy.

Near the southeastern edge there is a distinct vegetation change to an area dominated almost exclusively by silver maple, with a minor component of slippery elm. This area appears to have started establishing in the 1960's and contains many very large maples, one reaching over 70" DBH (Appendix C, Photo 4). The herbaceous stratum is dominated by various sedge species including Eastern woodland sedge and James' sedge.

### **2.2.2 Central Woodland**

At 25 acres, the Central Woodland is the largest forested area in the project boundary. It can be broken up into four general areas/forest types.

The vast majority of the area contains young and even-aged forest (~30 years old), composed of a mosaic of gentle ridges and low, wet swales. Most trees in this area range from 12-20" DBH. The ridges are dominated by white mulberry, and black cherry, with a component of ash-leaf maple and silver maple. The shrub layer is very thick, dominated by gray dogwood, bush honeysuckle, and rambler rose. The herbaceous stratum is dominated by clustered black-snakeroot, Canadian honewort, and sticky-willy. The low, wet areas have a very open canopy dominated primarily by black willow. A few shrubs, including rambler rose and black elder are also present. The herbaceous stratum consists of smooth brome, reed canary grass, wild parsnip, late goldenrod, spotted touch-me-not, various sedges and Canadian thistle. A higher-quality sedge meadow was noted near the eastern edge and a plum thicket was also noted near the southern woodland edge.

Within the generally low-quality forested complex is a noticeably higher-quality area, dominated largely by oak species, including northern red oak, pin oak, and burr oak. Of note, one large (>30" DBH) burr oak was recorded that can be seen in aerial photography dating back to the earliest available aerial photography in the 1930's (Appendix C, Photo 7 and Appendix A). Here, the understory is more open than in the lower quality areas, dominated primarily by clustered black-snakeroot, Canadian honewort, garlic-mustard, and spotted touch-me-not.

The north-south oriented finger near the eastern edge of the Central Woodland is very low-quality, dominated by mulberry, and hackberry, with a minor ash-leaf maple and black cherry component. The shrub layer is overwhelmingly dominated by a thicket of gray dogwood, and the herbaceous layer is composed almost entirely of smooth brome and garlic-mustard.

### **2.2.3 South Woodland**

The South Woodland is approximately 9 acres and can also generally be described as a young (~30 years old), relatively even-aged stand; although one small clump of trees near the southeast corner, as well as some trees growing along the fence line began establishing in the 1980's. This woodland is similar to the Central Woodland and can be described as a series of gentle upland ridges with low, wet areas between. The

eastern edge is a thicket of wild plum, gray dogwood and rambler rose with an understory of clustered black-snakeroot, Canadian honewort.

The ridge areas are dominated by 12-26" DBH black cherry and white mulberry, with a few large (30" DBH) Siberian elms. The shrub layer is generally very thick with gray dogwood, ash-leaf maple saplings, and bush honeysuckle. The understory is divided relatively equally between clustered black-snakeroot, Canadian honewort, and garlic-mustard, with some poison ivy.

The low lying swales generally lack a proper canopy, although small mulberries and ash-leaf maples are present, along with gray dogwood, black elder, and rambler rose. The herbaceous stratum is dominated by reed canary grass, stinging nettle, Canadian thistle, and smooth brome and various sedges, including Northwest Territory sedge.

Figure 2: Woodland Inventory

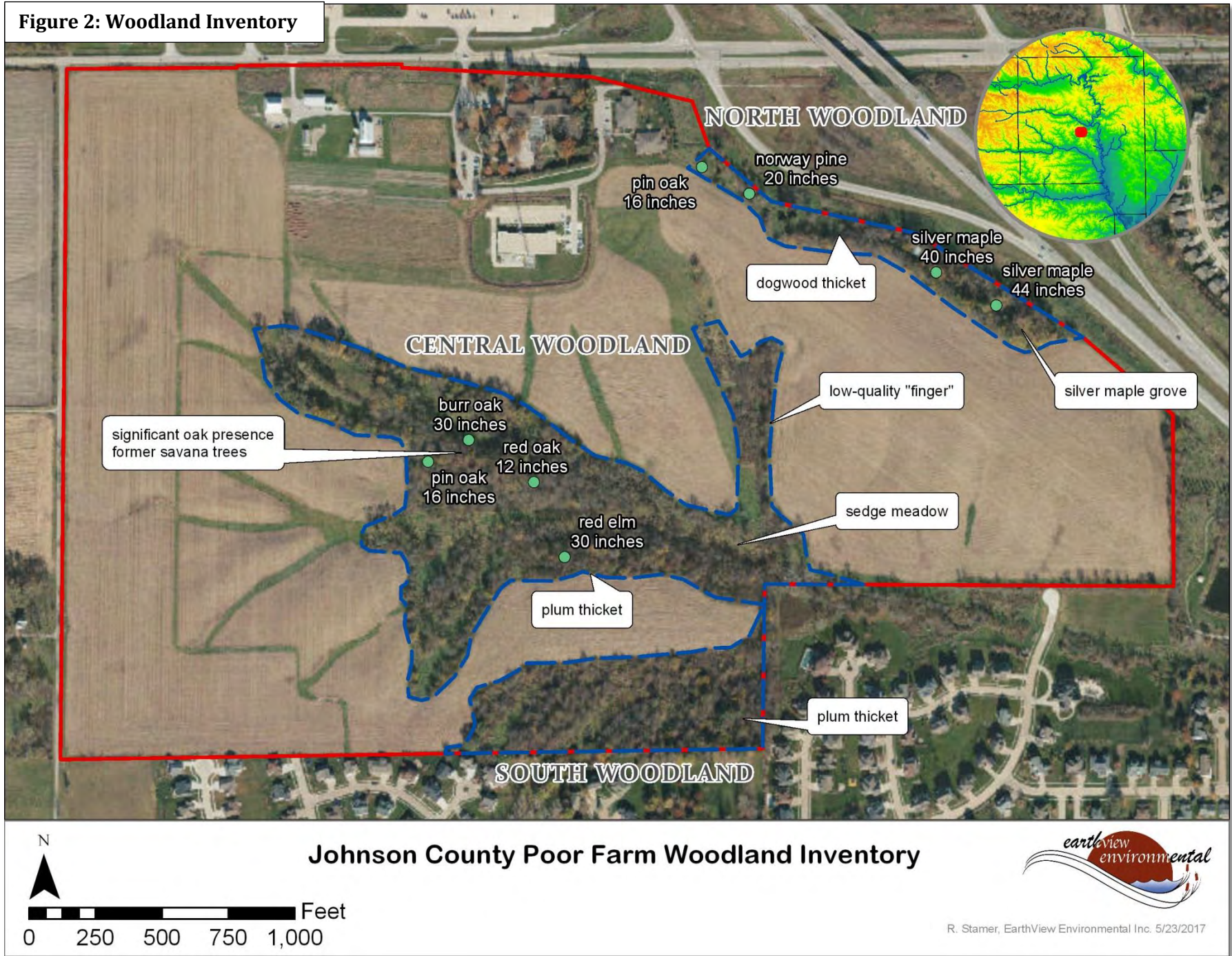

### 3.0 Conclusions

EarthView inventoried approximately 41 acres of woodland at the Johnson County Poor Farm. Most of these woodland areas are low-quality, early successional areas. However, as described, some notable areas of elevated diversity exist within the site.

*This report has been prepared for the exclusive use of our client, and for specific application to the project discussed. To the best of my knowledge the above statements, attachments, including those labeled and identified as enclosures, and all conclusions are true, accurate, and based on current environmental principles and science. No warranties, either expressed or implied, are intended or made. In the event that changes in the nature, design or location of the project as shown are planned, the conclusions and recommendations contained on this form shall not be considered valid unless EarthView Environmental, Inc. reviews the changes and either verifies or modifies the conclusions of this form in writing. This report has been prepared by:*

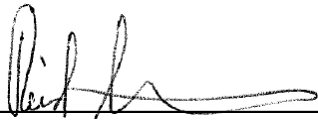

Reid Stamer, Restoration Ecologist

5/25/2017

Date



**Appendix A: 1930's Aerial Photo**

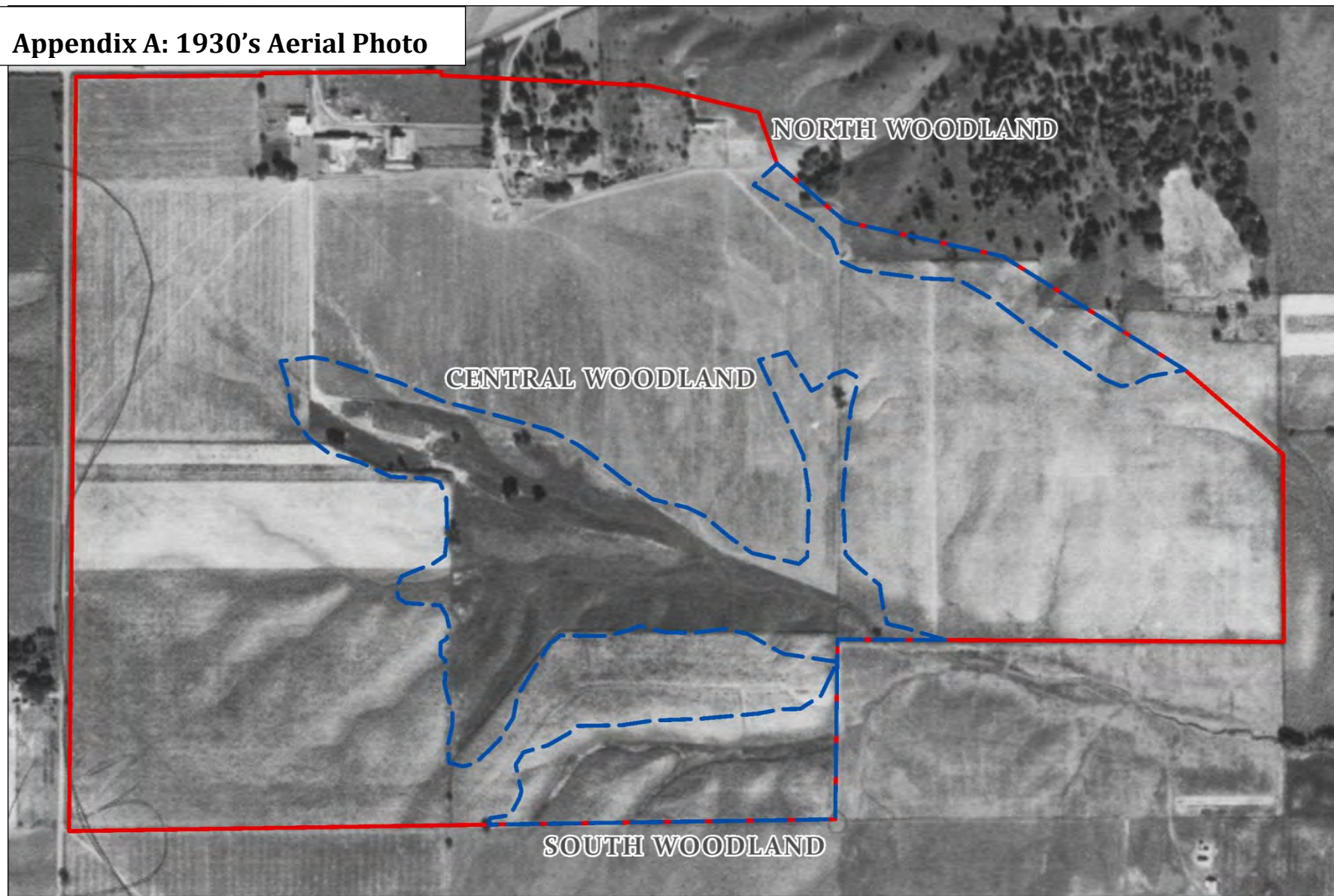

**Johnson County Poor Farm Woodland Inventory**

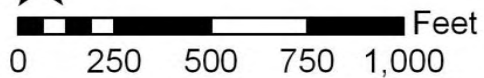

R. Stamer, EarthView Environmental Inc. 5/23/2017  
USDA, Iowa State University

**Appendix B: 1960's Aerial Photo**

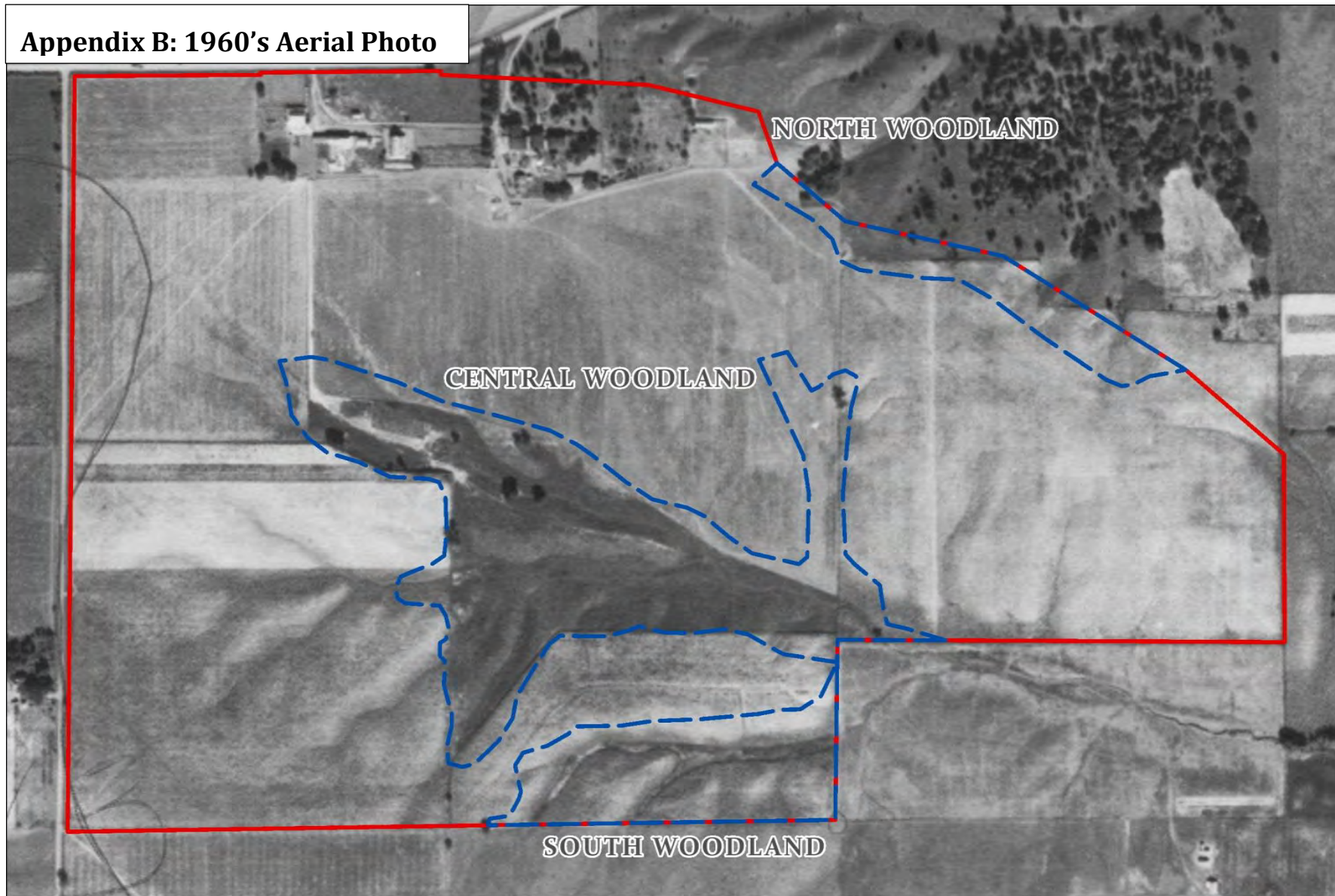

**Johnson County Poor Farm Woodland Inventory**

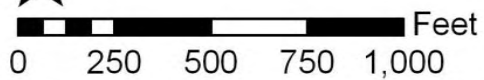

R. Stamer, EarthView Environmental Inc. 5/23/2017  
USDA, Iowa State University

## Appendix C: Site Photos



**Photo 1: North Woodland**  
Near western edge, facing southeast  
Date: 5/22/2017



**Photo 2: North Woodland**  
Dogwood thicket  
Date: 5/22/2017



**Photo 3: North Woodland**  
Silver maple grove, near southeast corner  
Date: 5/22/2017



**Photo 4: North Woodland**

Very large silver maple

Date: 5/22/2017



**Photo 5: Central Woodland**

Low, wet swale in drainageway

Date: 5/22/2017



**Photo 6: Central Woodland**

Far northwest lobe, facing northwest

Date: 5/22/2017



**Photo 7: Central Woodland**  
Burr oak, visible on 1930's aerial photo  
Date: 5/22/2017



**Photo 8: Central Woodland**  
American plum thicket near southern edge  
Date: 5/22/2017



**Photo 9: Central Woodland**  
Sedge meadow near eastern edge  
Date: 5/22/2017



**Photo 10: Central Woodland**  
North-south finger near eastern edge  
Date: 5/22/2017



**Photo 8: South Woodland**  
American plum thicket near eastern edge  
Date: 5/22/2017

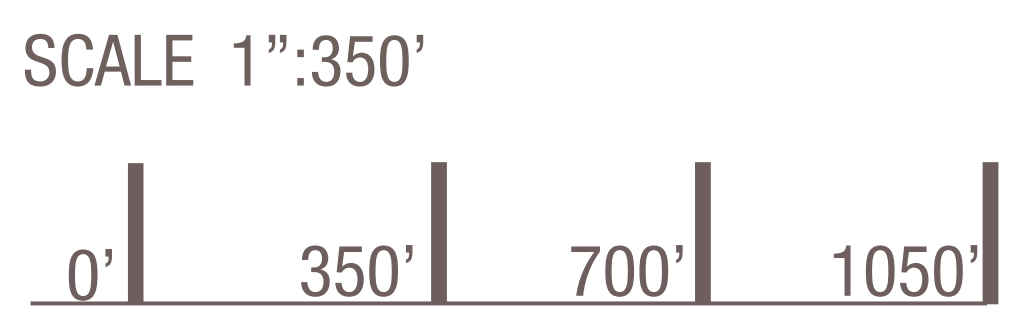

**Photo 9: South Woodland**  
Low, wet swale between upland ridges  
Date: 5/22/2017

## Appendix D: Cumulative Species List

Species	Common	Status
<i>Acer negundo</i>	Ash-Leaf Maple	FAC
<i>Acer saccharinum</i>	Silver Maple	FACW
<i>Alliaria petiolata</i>	Garlic-Mustard	FAC
<i>Asclepias syriaca</i>	Common Milkweed	FACU
<i>Bromus inermis</i>	Smooth Brome	FACU
<i>Carex blanda</i>	Eastern Woodland Sedge	FAC
<i>Carex jamesii</i>	James' Sedge	UPL
<i>Carex utriculata</i>	Northwest Territory Sedge	OBL
<i>Cirsium arvense</i>	Canadian Thistle	FACU
<i>Cornus racemosa</i>	Gray Dogwood	FAC
<i>Cryptotaenia canadensis</i>	Canadian Honewort	FAC
<i>Dactylis glomerata</i>	Orchard Grass	FACU
<i>Fraxinus pennsylvanica</i>	Green Ash	FACW
<i>Galium aparine</i>	Sticky-Willy	FACU
<i>Impatiens capensis</i>	Spotted Touch-Me-Not	FACW
<i>Juniperus virginiana</i>	Eastern Red-Cedar	FACU
<i>Lonicera maackii</i>	Amur Honeysuckle	UPL
<i>Morus alba</i>	White Mulberry	FAC
<i>Pastinaca sativa</i>	Wild Parsnip	UPL
<i>Phalaris arundinacea</i>	Reed Canary Grass	FACW
<i>Picea pungens</i>	Colorado Spruce	UPL
<i>Pinus resinosa</i>	Red Pine	FACU
<i>Populus deltoides</i>	Eastern Cottonwood	FAC
<i>Prunus americana</i>	American Plum	UPL
<i>Prunus americana</i>	American Plum	UPL
<i>Prunus serotina</i>	Black Cherry	FACU
<i>Quercus macrocarpa</i>	Burr Oak	FAC
<i>Quercus palustris</i>	Pin Oak	FACW
<i>Quercus rubra</i>	Northern Red Oak	FACU
<i>Rosa multiflora</i>	Rambler Rose	FACU
<i>Rubus allegheniensis</i>	Allegheny Blackberry	FACU
<i>Salix nigra</i>	Black Willow	OBL
<i>Sambucus nigra</i>	Black Elder	FACW
<i>Sanicula odorata</i>	Clustered Black-Snakeroot	FAC
<i>Solidago gigantea</i>	Late Goldenrod	FACW
<i>Toxicodendron radicans</i>	Eastern Poison Ivy	FAC
<i>Ulmus pumila</i>	Siberian Elm	UPL
<i>Ulmus rubra</i>	Slippery Elm	FAC
<i>Urtica dioica</i>	Stinging Nettle	FACW

# SIGNAGE LOCATION PLAN







### Monument Sign

**Height:** 16'-9"  
**Width:** 10'-0"  
**Sign Material:** Weathering Steel with Aluminum Lettering  
**Additional Materials:** 4"x4" Dimensional Lumber with Steel Brackets;  
Limestone Base with 2" cap  
**Base:** Stacked Limestone with 2" Cap



### Pedestrian Sign

**Height:** 5'-0"  
**Width:** 1'-9"  
**Sign Material:** Weathering Steel with Aluminum Lettering and Cutout



### Overhead Pedestrian Sign

**Height:** 9'-0"  
**Width:** 4'-6"  
**Sign Material:** Weathering Steel with Cutout Lettering  
**Additional Materials:** 4"x4" Dimensional Lumber Post with Steel Plating at Base

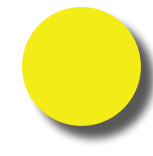
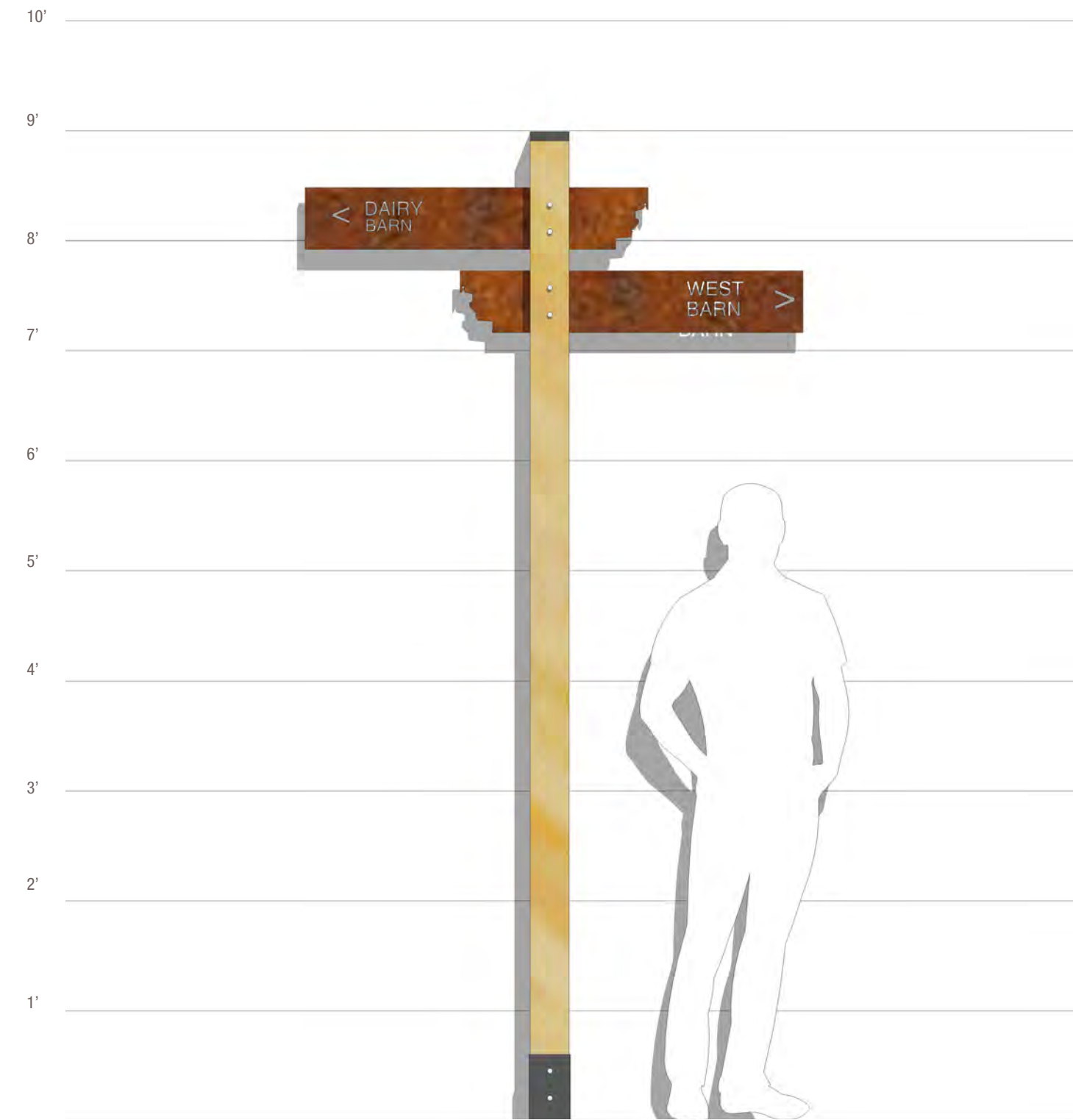

### Pedestrian Marker

**Height:** ± 4'-0"  
**Width:** ± 2'-3"  
**Sign Material:** Steel Sign  
**Additional Materials:** Limestone Post

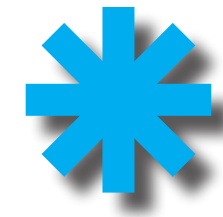
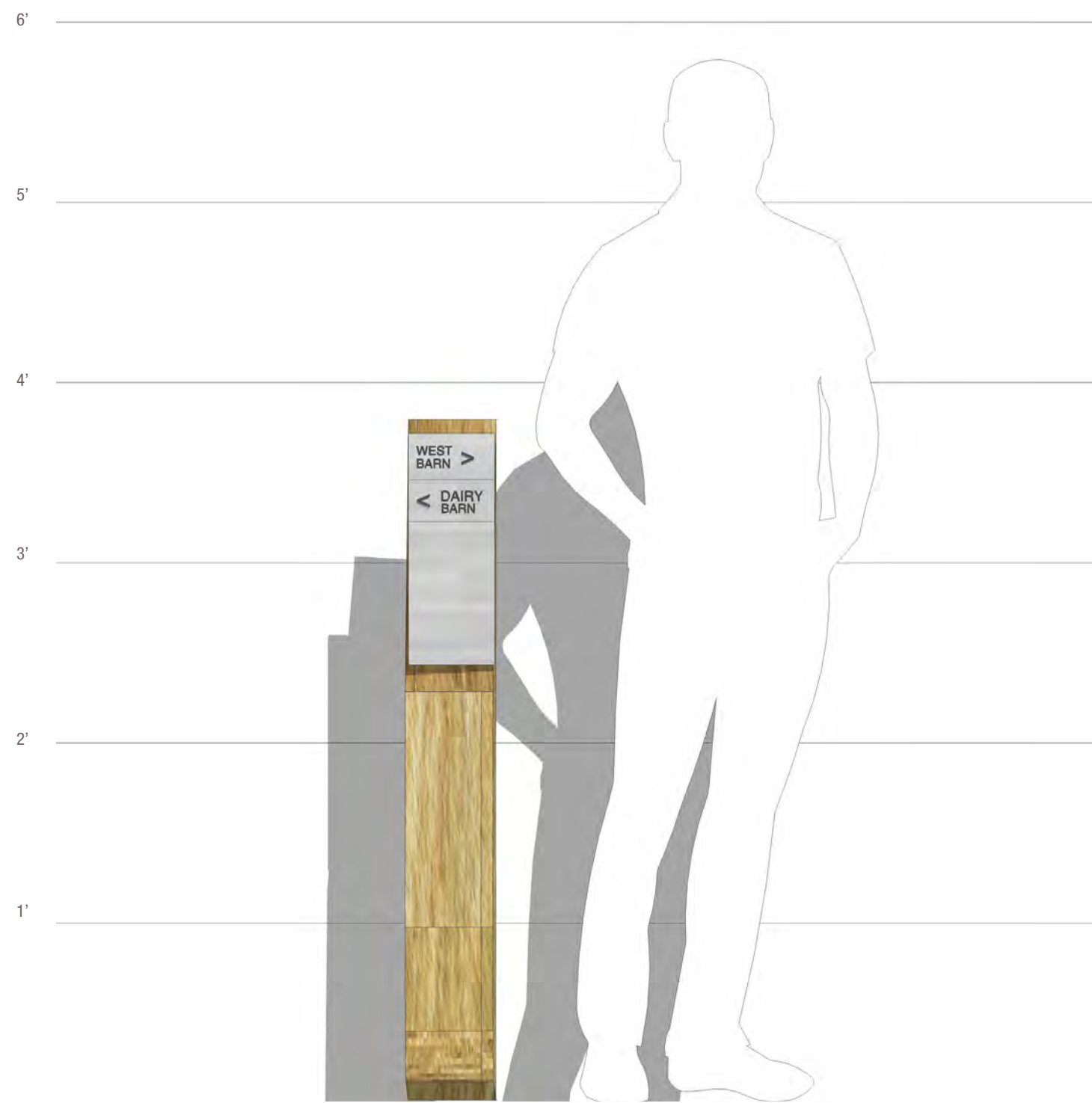

### Architectural Interpretive Sign

**Height:** 3'-0"  
**Width:** 3'-6"  
**Sign Material:** Weathering Steel Frame with Cutout and Steel Sign Face

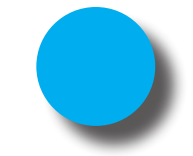

### Naturalized Interpretive Sign

**Height:** ± 2'-6"  
**Width:** ± 2'-6"  
**Sign Material:** Steel Sign  
**Additional Materials:** Fieldstone

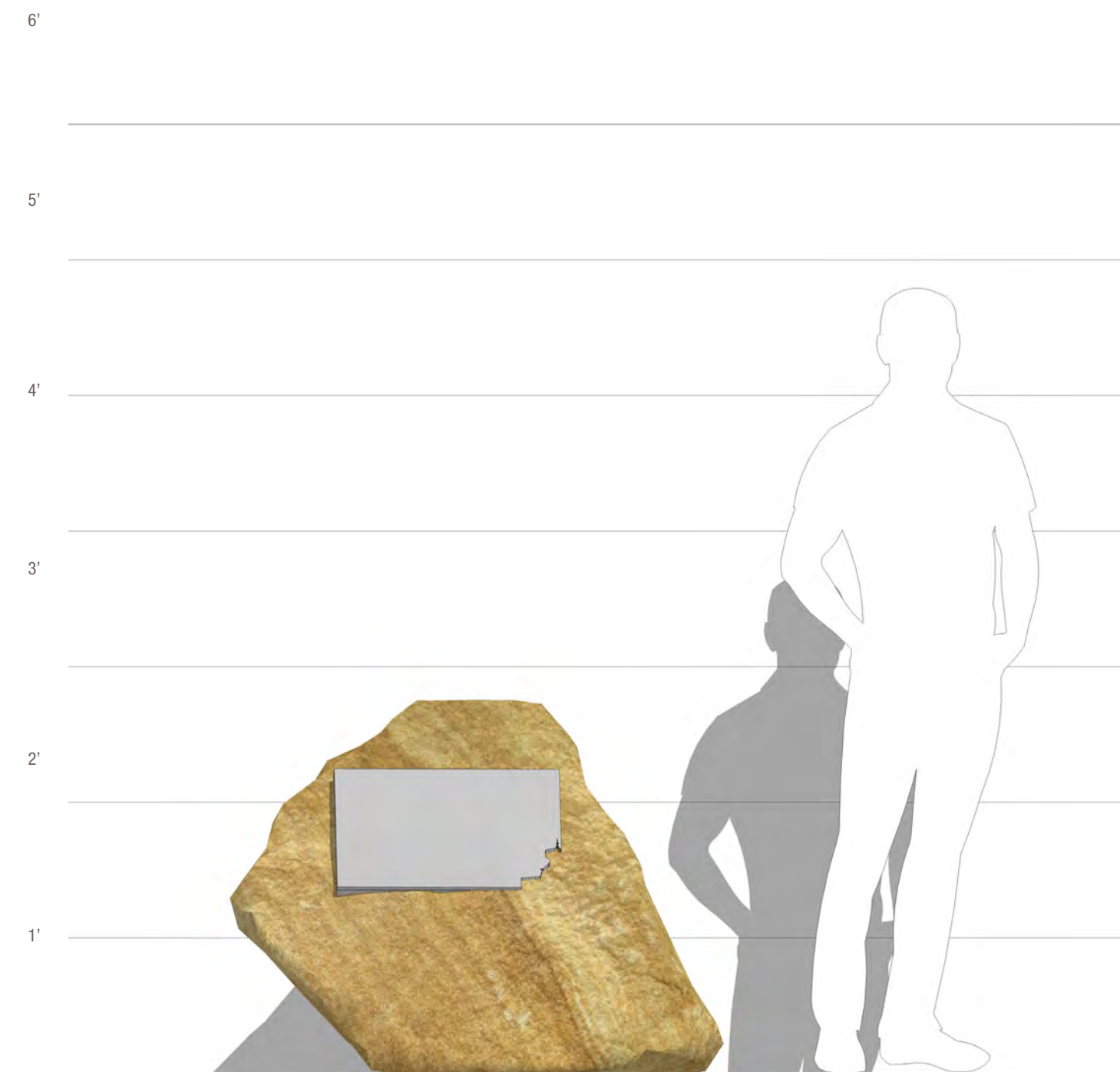

**Monument Sign**

**Height:** 16'-9"

**Width:** 10'-0"

**Sign Material:** Weathering Steel with Stainless Steel Lettering

**Additional Materials:** 4"x4" Dimensional Lumber with Steel Brackets; Limestone Base with 3" cap

**Base:** Stacked Limestone with 2" Cap

**Cost:** \$44,350 Per Sign



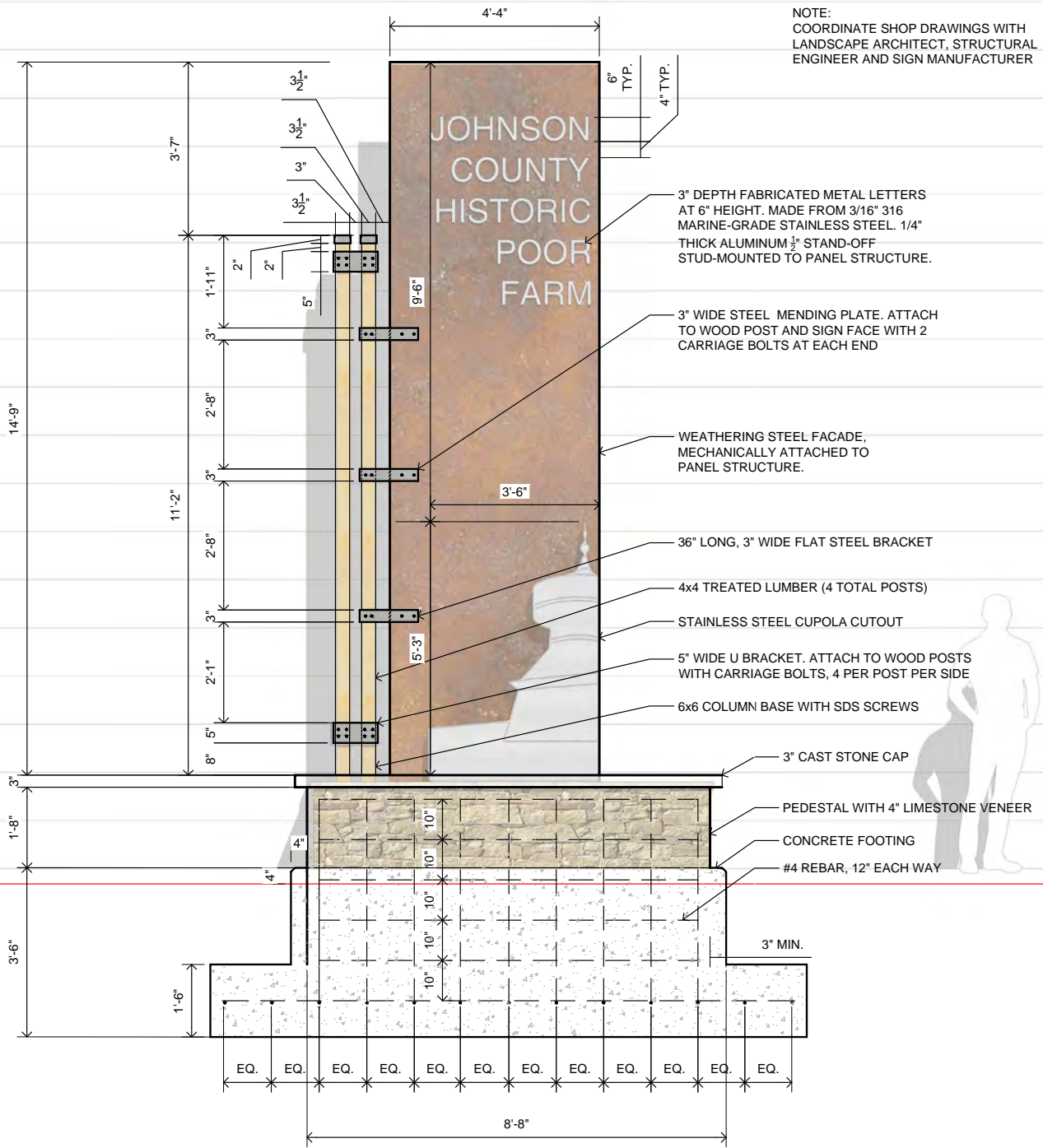

NOTE:  
 COORDINATE SHOP DRAWINGS WITH  
 LANDSCAPE ARCHITECT, STRUCTURAL  
 ENGINEER AND SIGN MANUFACTURER

JOHNSON  
 COUNTY  
 HISTORIC  
 POOR  
 FARM

3" DEPTH FABRICATED METAL LETTERS  
 AT 6" HEIGHT. MADE FROM 3/16" 316  
 MARINE-GRADE STAINLESS STEEL. 1/4"  
 THICK ALUMINUM 1/2" STAND-OFF  
 STUD-MOUNTED TO PANEL STRUCTURE.

3" WIDE STEEL MENDING PLATE. ATTACH  
 TO WOOD POST AND SIGN FACE WITH 2  
 CARRIAGE BOLTS AT EACH END

WEATHERING STEEL FACADE,  
 MECHANICALLY ATTACHED TO  
 PANEL STRUCTURE.

36" LONG, 3" WIDE FLAT STEEL BRACKET

4x4 TREATED LUMBER (4 TOTAL POSTS)

STAINLESS STEEL CUPOLA CUTOUT

5" WIDE U BRACKET. ATTACH TO WOOD POSTS  
 WITH CARRIAGE BOLTS, 4 PER POST PER SIDE

6x6 COLUMN BASE WITH SDS SCREWS

3" CAST STONE CAP

PEDESTAL WITH 4" LIMESTONE VENEER

CONCRETE FOOTING

#4 REBAR, 12" EACH WAY



EQ. EQ. EQ. EQ. EQ. EQ. EQ. EQ. EQ. EQ. EQ.

8'-8"

**PEDESTRIAN SIGN**

**Height:** 5'-0"

**Width:** 1'-9"

**Sign Material:** Weathering Steel with Stainless Steel Lettering and Cutout

**Cost:** \$14,800 Per Sign



6" WIDE STEEL SUPPORT (BEHIND)

2" TALL LETTERS MADE FROM 3/16"  
316 MARINE-GRADE STAINLESS STEEL.  
1/2" STAND-OFF STUD-MOUNTED TO  
PANEL STRUCTURE.

STAINLESS STEEL CUPOLA CUTOUT 1"  
STANDOFF. STUD MOUNTED TO SIGN

WEATHERING STEEL PANEL

18" SONOTUBE FOOTING

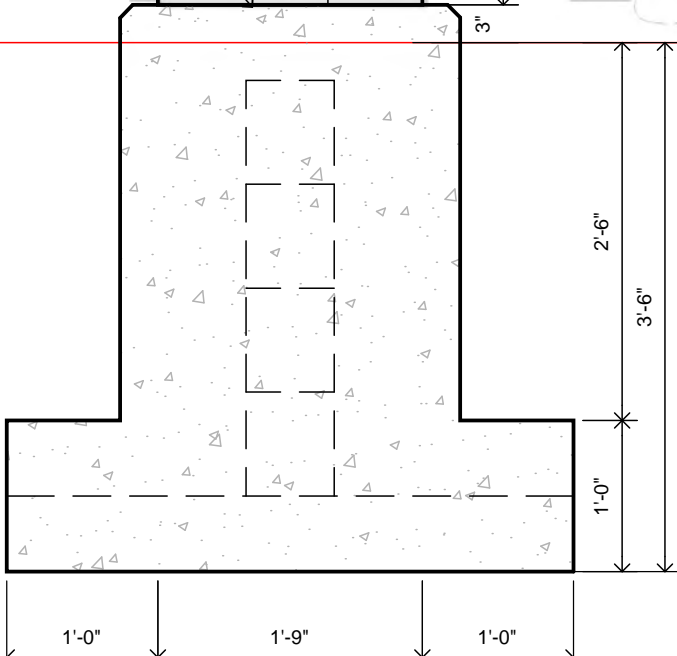
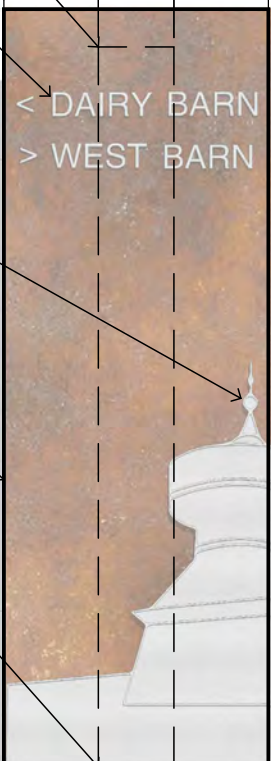
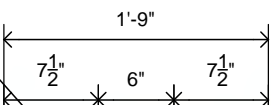

**Overhead Pedestrian Sign**

**Height:** 9'-0"

**Width:** 4'-6"

**Sign Material:** Weathering Steel with Cutout Lettering

**Additional Materials:** 4"x4" Dimensional Lumber Post with Steel Plating at Base

**Cost:** \$7,200 Per Sign

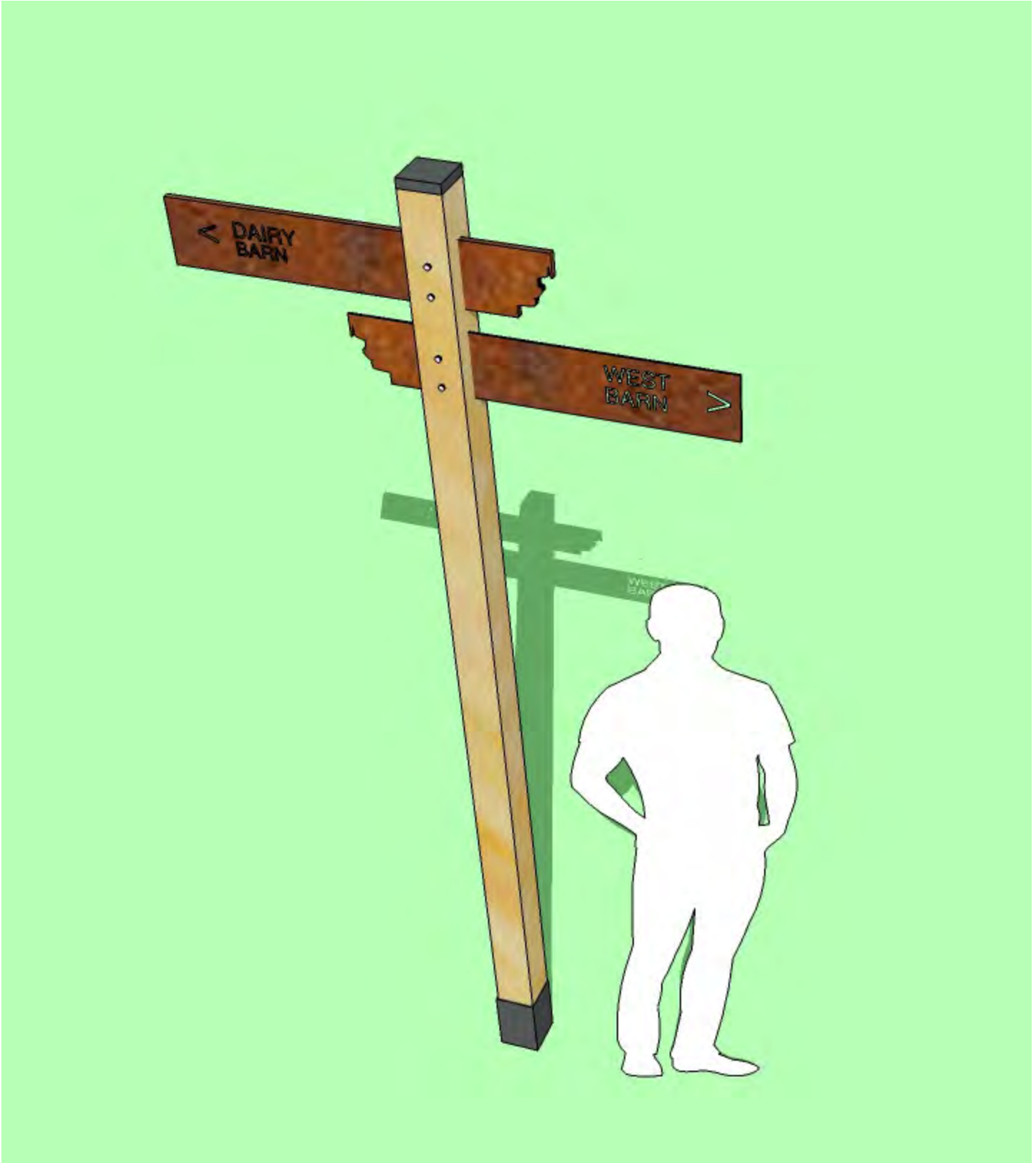

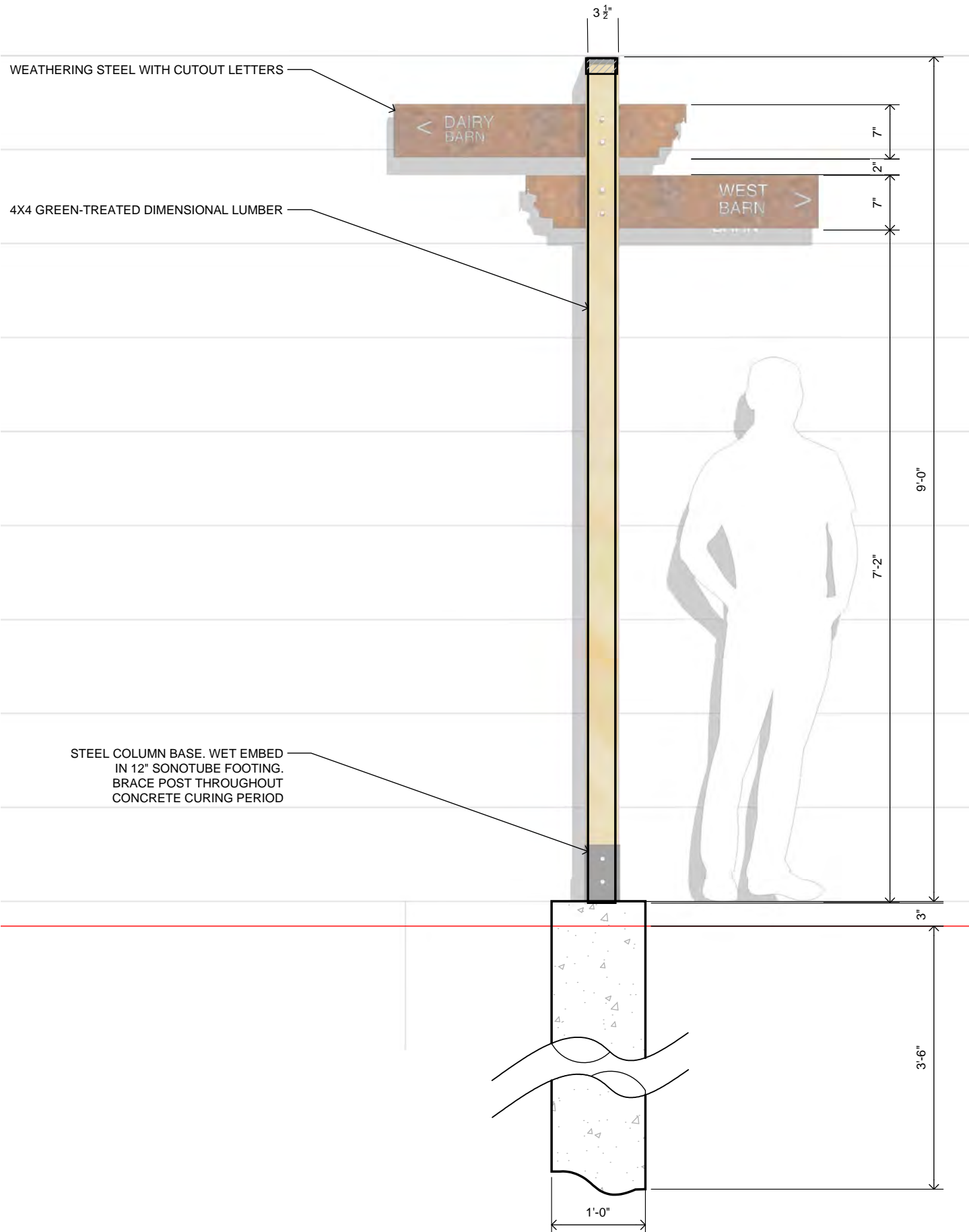

**Pedestrian Marker**

**Height:** ± 4'-0"

**Width:** ± 2'-3"

**Sign Material:** Stainless Steel Sign

**Additional Materials:** Limestone Post

**Cost:** \$2,650 Per Sign

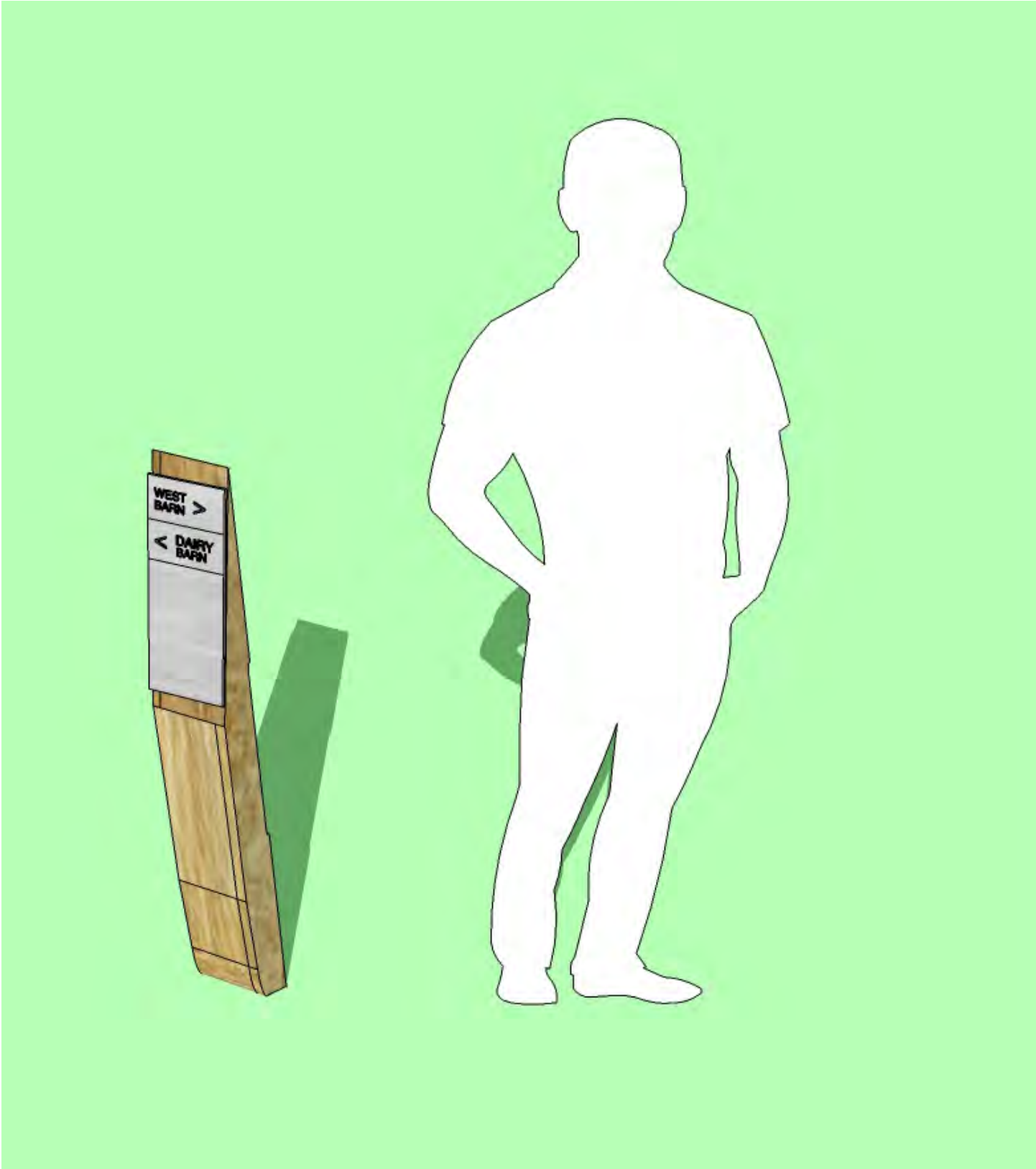



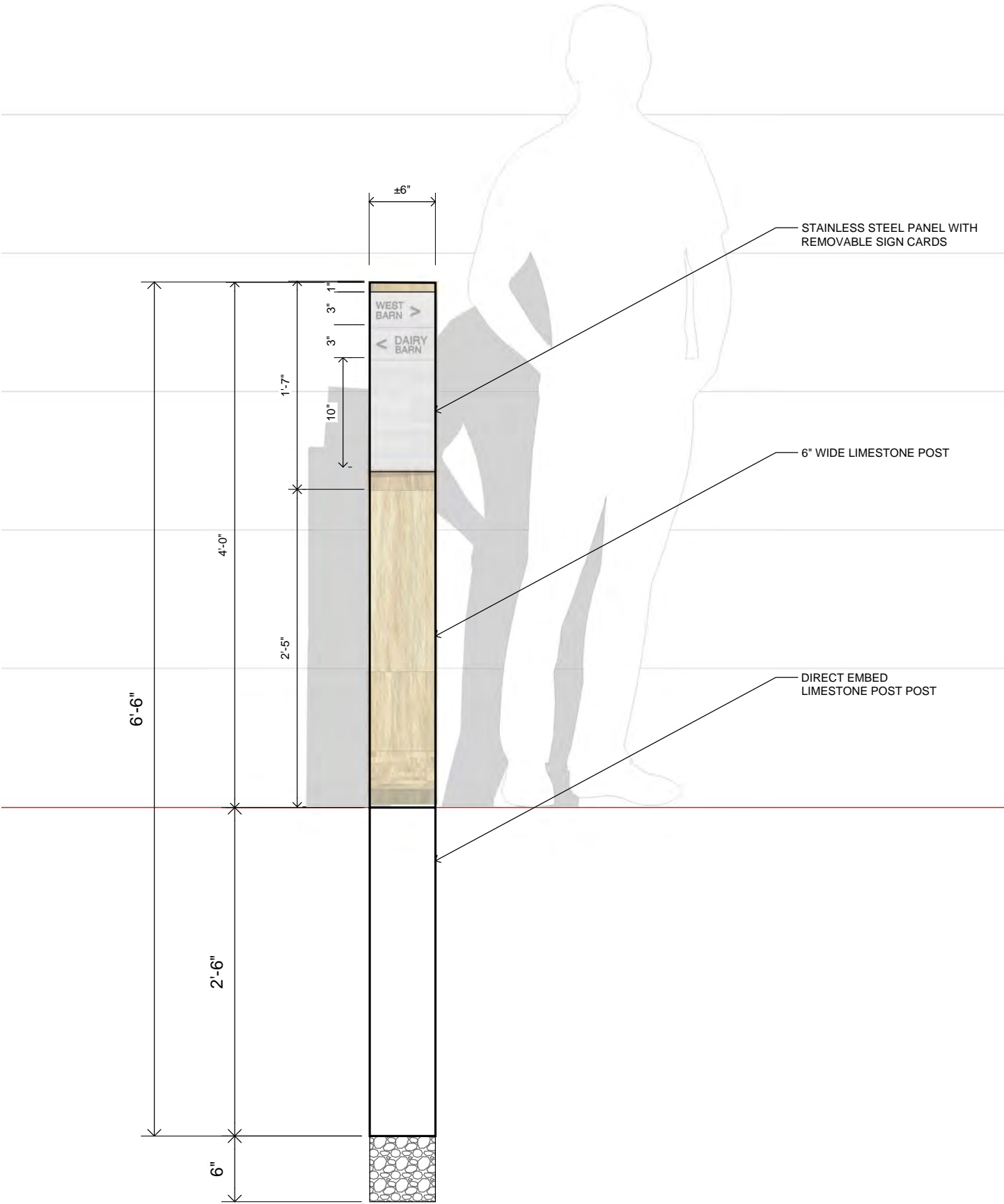

**Interpretive Sign - Architectural**

**Height:** 3'-0"

**Width:** 3'-6"

**Sign Material:** Weathering Steel Frame with Cutout and Stainless Steel Sign Face

**Cost:** \$10,000 Per Sign



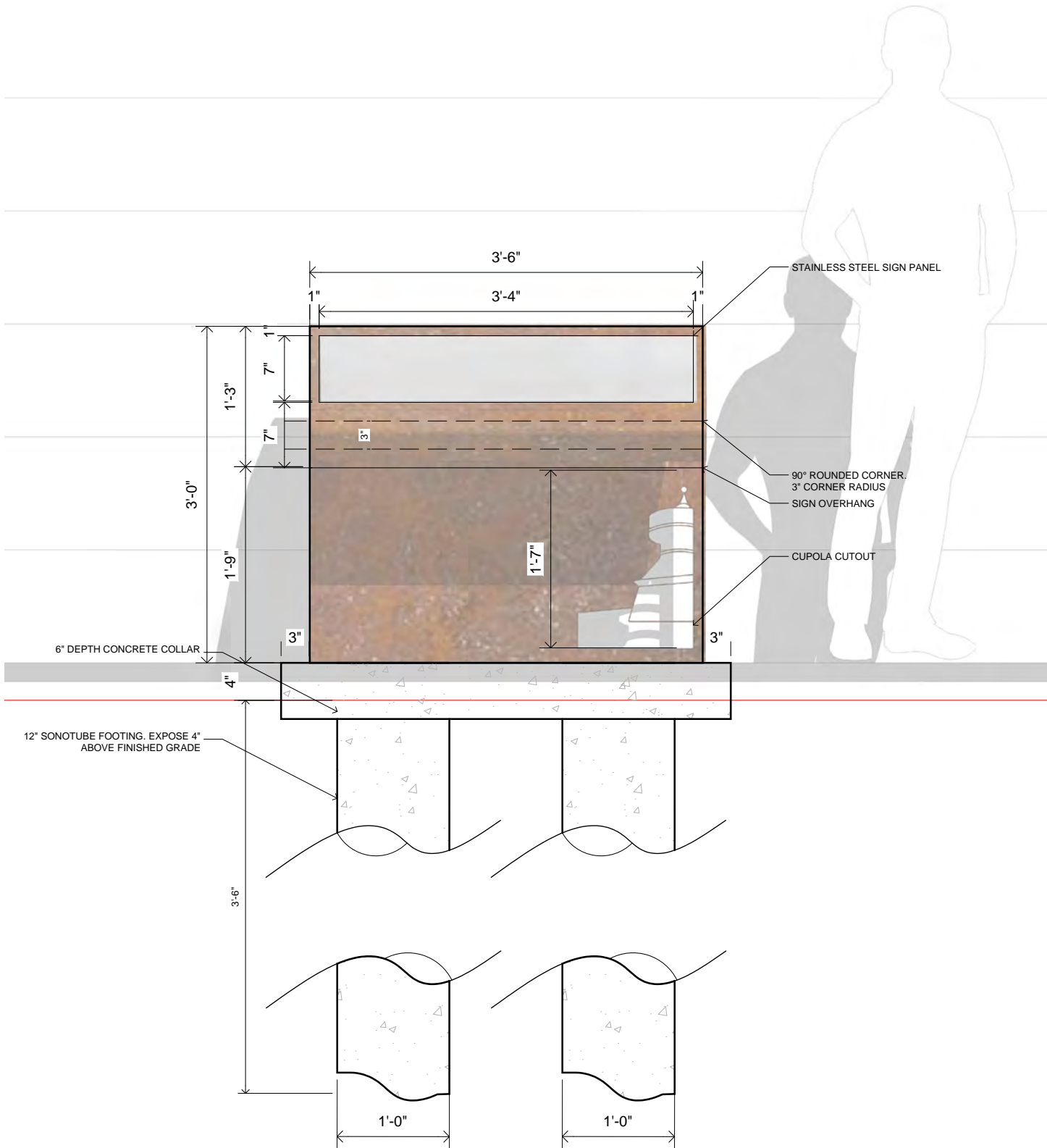

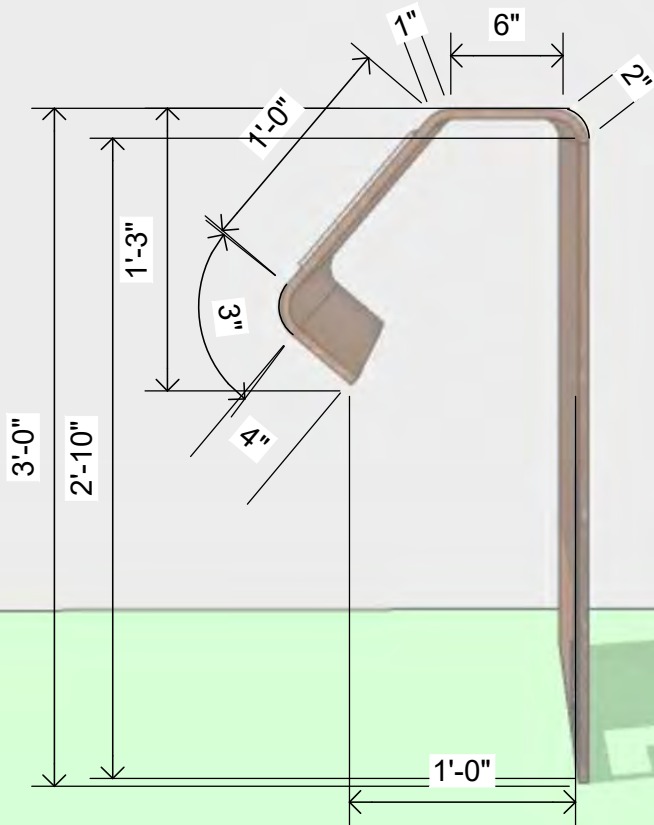

**Interpretive Sign - Naturalized**

**Height:** ± 2'-6"

**Width:** ± 3'-8"

**Sign Material:** Stainless Steel Plaque

**Additional Materials:** Fieldstone

**Cost:** \$4,040 Per Sign

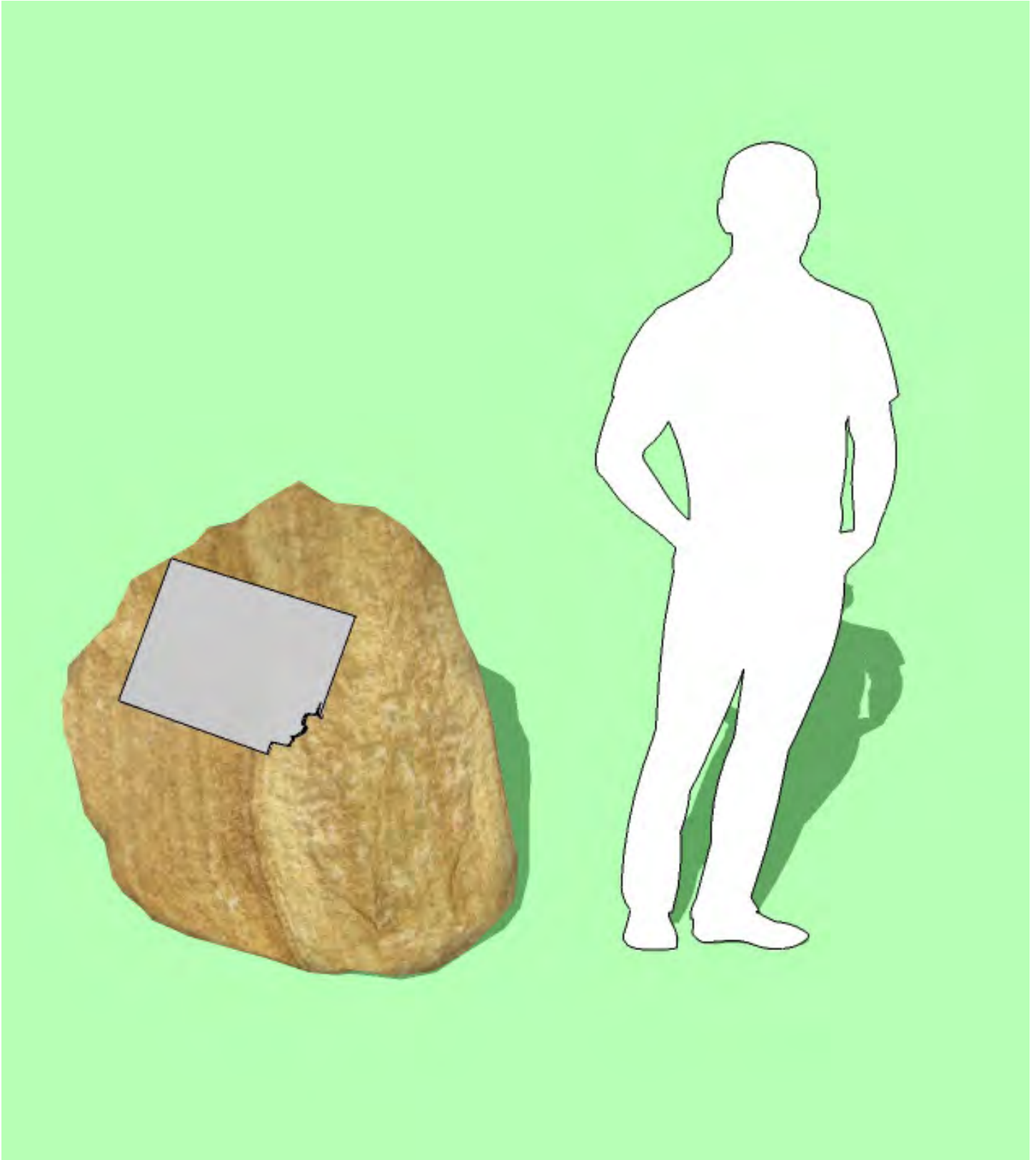

OVERALL FIELDSTONE. HEIGHT AND WIDTH SHOWN ARE APPROXIMATE. SELECT STONES WITHIN 8" OF EITHER DIMENSION.

STAINLESS STEEL PLAQUE WITH CUPOLA CUTOUT IN BOTTOM RIGHT CORNER

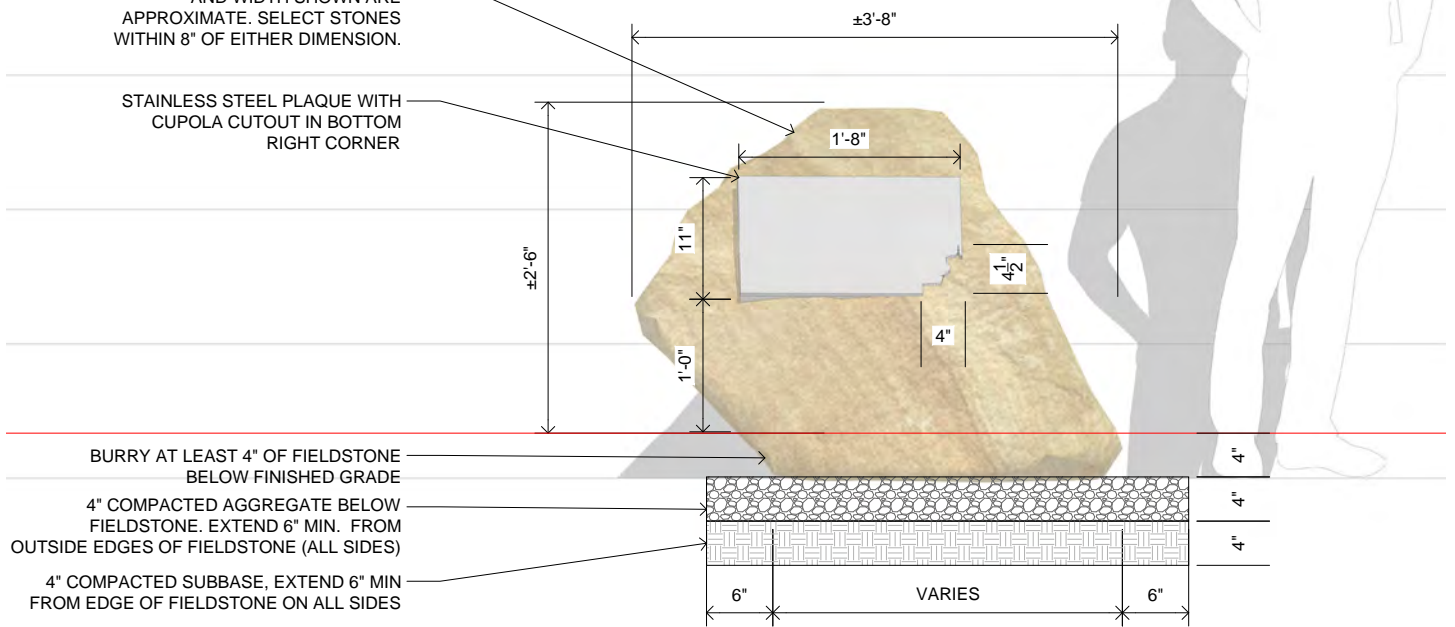

**Probable Construction Cost Opinion**

The amounts stated herein are our best estimate of probable construction costs based on current information. Because costs are influenced by market conditions, changes in project scope, and other factors beyond our control, we cannot ensure that actual construction costs will equal this cost opinion.

**Johnson County Poor Farm**

Iowa City, Iowa

17106  
10/30/2017

**Sign Pricing**

Site Costs	Qty	Unit	Unit Cost	Item Total	Remarks
<b>Monument Sign</b>					
Site Preparation	1	EA	\$ 4,000.00	\$ 4,000.00	Staging, excavation and fencing
Weathering Steel Sign Panel	1	EA	\$ 20,000.00	\$ 20,000.00	Includes internal support structure and weathering steel skin. Bid provided by ASI. Contact: Pat Mescher
Cupola Cutout	1	EA	\$ 4,000.00	\$ 4,000.00	
Limestone Sign Pedestal	1	EA	\$ 7,000.00	\$ 7,000.00	Includes cap
PCC Footing	50	CY	\$ 150.00	\$ 7,500.00	Spread footing below sign. Includes rebar.
4x4 Dimnsional Lumber Post	4	EA	\$ 150.00	\$ 600.00	Pressure-treated lumber - 15' length cut to size
Post Anchor	4	EA	\$ 50.00	\$ 200.00	Includes connecting hardware
Post Cap	4	EA	\$ 50.00	\$ 200.00	Includes connecting hardware
U Bracket	2	EA	\$ 200.00	\$ 400.00	Includes connecting hardware
Mending Plates	3	EA	\$ 150.00	\$ 450.00	Includes connecting hardware
<b>Subtotal</b>				<b>\$44,350.00</b>	
<b>Pedestrian Sign</b>					
Site Preparation	1	EA	\$ 2,000.00	\$ 2,000.00	Staging, excavation and fencing
Weathering Steel Sign Panel	1	EA	\$ 6,000.00	\$ 6,000.00	Includes internal support structure and weathering steel skin
Cupola Cutout	1	EA	\$ 3,000.00	\$ 3,000.00	
PCC Footing	7	CY	\$ 300.00	\$ 2,100.00	Spread footing below sign. Includes rebar.
Sign Letters	20	EA	\$ 60.00	\$ 1,200.00	Channel lettering
Anchor plate	1	EA	\$ 500.00	\$ 500.00	Includes connecting hardware
<b>Subtotal</b>				<b>\$14,800.00</b>	
<b>Overhead Sign</b>					
Site Preparation	1	EA	\$ 1,000.00	\$ 1,000.00	Staging, excavation and fencing
4x4 Dimnsional Lumber Post	1	EA	\$ 150.00	\$ 150.00	Pressure-treated lumber - 10' length cut to size
Weathering Steel Sign Blades	2	EA	\$ 2,000.00	\$ 4,000.00	Includes custom cupola cutout
Lumber Post Cap	1	EA	\$ 50.00	\$ 50.00	
PCC Footing	5	CY	\$ 300.00	\$ 1,500.00	Sonotube footing
Anchor plate	1	EA	\$ 500.00	\$ 500.00	Includes connecting hardware
<b>Subtotal</b>				<b>\$7,200.00</b>	
<b>Pedestrian Marker</b>					
Site Preparation	1	EA	\$ 500.00	\$ 500.00	Staging, excavation and fencing
Limestone Post	1	EA	\$ 500.00	\$ 500.00	6'-6" tall, 6" width
Stainless Steel Sign Panel	1	EA	\$ 1,000.00	\$ 1,000.00	Includes custom cupola cutout
Aggregate Subbase	1	CY	\$ 150.00	\$ 150.00	Direct embed limestone post
Anchor plate	1	EA	\$ 500.00	\$ 500.00	Includes connecting hardware
<b>Subtotal</b>				<b>\$2,650.00</b>	
<b>Interpretive Sign - Architectural</b>					
Site Preparation	1	EA	\$ 1,500.00	\$ 1,500.00	Staging, excavation and fencing
Custom Formed Weathering Steel Sign	1	EA	\$ 4,500.00	\$ 4,500.00	Coordinate with steel manufacturing service
Stainless Steel Sign Panel	1	EA	\$ 1,500.00	\$ 1,500.00	Includes custom cupola cutout
PCC Footing	10	CY	\$ 150.00	\$ 1,500.00	Concrete collar on sonotube footings
Anchor plate	2	EA	\$ 500.00	\$ 1,000.00	Includes connecting hardware
<b>Subtotal</b>				<b>\$10,000.00</b>	
<b>Interpretive Sign - Naturalized</b>					
Site Preparation	1	EA	\$ 500.00	\$ 500.00	Staging, excavation and fencing
Compacted Aggregate Subbase	4	CF	\$ 10.00	\$ 40.00	Includes compacting subgrade
Fieldstone	1	EA	\$ 2,000.00	\$ 2,000.00	Coordinate with steel manufacturing service
Stainless Steel Sign Panel	1	EA	\$ 1,500.00	\$ 1,500.00	Includes custom cupola cutout
<b>Subtotal</b>				<b>\$4,040.00</b>	

Site preparation figures subject to change if not installed as part of one contiguous process

Structural engineer to review construction details before construction

## Affordable Rental

### Low-Income Housing Tax Credits (LIHTC)

Since 1996, the Low-Income Housing Tax Credit program has developed 9 of 10 affordable rental homes in the USA.

- Federal Government issues income tax credits to each state (amount of credits is formulaic based on population).
- Each State Finance agency drafts a qualified allocation plan which describes the criteria governing the competition for the credits.
- Developers apply for the credits and State Finance agency awards credits to developer applicants.
- Developer finds investors to purchase the credits (usually through a tax credit syndicator). Investor offers equity to the project in exchange for credits.
- Typically the LIHTC equity provides 60-70% of the project's financing; 20% comes from private debt; remaining financing comes from various other subsidies.
- The State, Syndicator and Investor monitor the program for compliance
- Homes must remain affordable for 30 years as rental homes to low-income households.
- Residents incomes must be below 60% of the HUD established Area Median Income.
- Investors get 10 years of credits and must remain in the project for 15 years.
- Qualified non-profits have right of first refusal to purchase homes after year 15.



#### PROS

- Largest source of funding for affordable rental housing.
- Tax Credit Equity lowers the amount of debt on the project allowing for lower rents.
- Rigorous monitoring and required replacement and operation reserves results in upkeep of the homes.
- Homes can be constructed with attractive and energy efficient design standards.
- Assessor determines property taxes owed based on project's income.

#### CONS

- Complex program and structure; must be owned by a for-profit to generate income tax liability. Typically the project is a standalone Limited Partnership. Developer becomes the General Partner and is responsible for all management and monitoring duties as a .01% owner.
- Highly competitive application process with significant pre-development costs.
- Risk to developer if credits are not delivered to investor throughout the 10 year credit period.
- Multiple sources of financing can add layers of compliance requirements.
- Need a Certified Tax Credit Professional to ensure ongoing compliance and reporting.

#### EXAMPLE OF TAX CREDIT PROJECT

Incomes must be either 40% AMI or 60%AMI. Rents at \$704 or \$906 (3 Bedroom)

Household Size	40%	Hourly Wage	60%	Hourly Wage
3	\$28,625	\$13.76	\$42,960	\$20.65
4	\$31,800	\$15.29	\$47,700	\$22.93
5	\$34,350	\$16.51	\$51,540	\$24.78
6	\$36,900	\$17.74	\$55,380	\$26.63

*Lower private debt allows significant rent reduction*



## Community Land Trust:

Community Land Trusts (CLTs) sell homes at affordable prices to income and mortgage qualified buyers while simultaneously leasing the land to the home buyer. This structure allows the CLT to control what happens to the home going forward and ensure the property remains affordable and well preserved.



### PROS

- The homes remain affordable over time.
- Limited equity formulas ensure all subsequent income and mortgage qualified buyers have home ownership opportunity.
- CLT essentially removes the land from the speculative market.
- Removal of the cost of the land allows homes to be constructed similar to surrounding homes and with desirable design standards.
- Can be attractive to lenders for Community Reinvestment Act requirements

### CONS

- Steep learning curve for lenders, underwriters and appraisers (usually work with only one lender, etc.)
- Steep learning curve for buyers

### Basic Structure of CLT

- Typically a non-profit
- Land is held by CLT
- Improvements (home) held by owner
- CLT and home owner enter into long term land lease; 99 years, renewable for additional 99.
- Home owner pays monthly land use fee
- Assessor – two parcels; land and improvements – generally home owner responsible for all taxes
- Re-sale formula in lease sets future sales price with limited equity to seller
- If seller cannot find income qualified buyer, lease guarantees CLT will buy home and re-sell

Resources: Institute for Community Economics; [www.community-wealth.org](http://www.community-wealth.org)

- Burlington Associates; [www.burlington-associates.com](http://www.burlington-associates.com)